

## Original manual (EN)

**ARX 12**

**ARX 16**

**ARX 16 K**

**ARX 20**

**Yanmar**

Serial No. 13000-

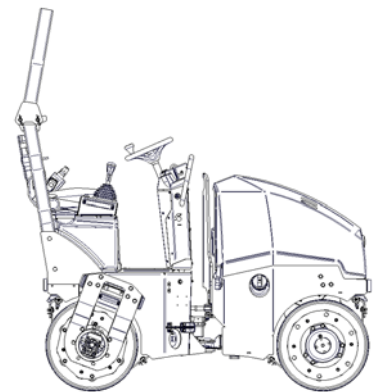





# Declaration of Conformity

This is to certify that the machine | group of machines indicated below conform(s) to the relevant basic safety and health requirements of the relevant EC directives in terms of their conception and design and in the form marketed by us.

This declaration shall cease to be valid in the event of any change made to the machine/group of machines after handover to the trader/user if such changes are not agreed with us.

<b>Name of machine or group of machines:</b>	Tandem roller & combined roller
<b>Model   Type:</b>	ARX 12, ARX 16, ARX 16 K, ARX 20
<b>Mode of functioning:</b>	Ground compaction
<b>Serial number:</b>	13,000 - 18,000
<b>Relevant EC directives:</b>	- Machinery Directive 2006/42/EC - Directive on Electromagnetic Compatibility 2004/108/EC - Noise Directive 2000/14/EC
<b>Applicable harmonized standards:</b>	EN 500-1, EN 500-4,
<b>Issuing testing office for noise tests:</b>	TÜV Austria Testing office number: 0408
<b>Machine type as per appendix I from 2000/14/EC:</b>	No.: 8
<b>Conformity assessment as per appendix VIII from 2000/14/EC:</b>	Unit verification ISO 9001 certificate no.: 30605
<b>Noise emissions:</b>	Recorded sound power level: 100dB(A) Guaranteed sound power level: 103dB(A)
<b>Manufacturer:</b>	Ammann Schweiz AG
<b>Address:</b>	Eisenbahnstrasse 25 CH-4901 Langenthal

**Signatures:**



<b>Name:</b>	H. Queder	Ch. Anliker
<b>Mode of functioning:</b>	Plant manager	Technology Manager

**Authorized representative:**

The technical documents are stored in the care of the above-mentioned persons

**Place, Date:**

Langenthal, March 2012



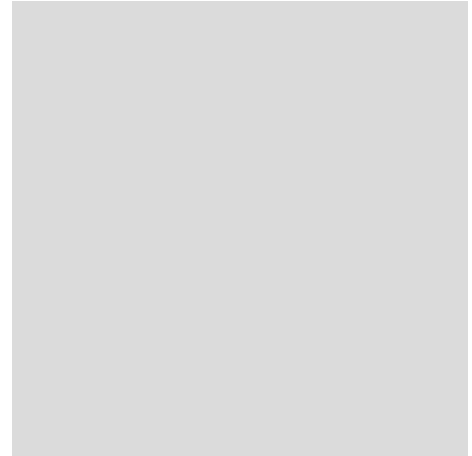

# Preface

Congratulations on your purchase of an Ammann compaction roller.

This quality of this compaction device is characterized by simple operation and maintenance and is the product of many years of Ammann experience in the field of road roller engineering.

Because the content of the deliverable depends on the order, the features of your roller may differ in some descriptions and pictures.

In order to avoid faults due to improper operation and maintenance we request that you read this operating manual with great care and keep it for later reference.

With kind regards

Ammann Schweiz AG  
Eisenbahnstrasse 25  
CH-4901 Langenthal

Phone: 0041 (0)62 916 61 61  
Fax: 0041 (0)62 916 64 03

[www.ammann-group.com](http://www.ammann-group.com)



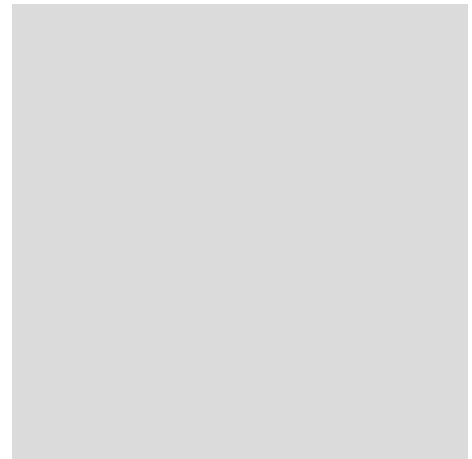

# Contents

<b>1</b>	<b>General</b> .....	<b>13</b>
1.1	About this manual .....	14
1.1.1	Target audience .....	14
1.1.2	Purpose .....	14
1.1.3	Overview of customer documentation .....	14
1.1.4	Validity of the manual .....	15
1.1.5	Storage of the manual .....	15
1.1.6	Technical changes .....	15
1.1.7	Copyrights .....	15
1.1.8	Spare parts .....	15
1.2	Structure of the manual .....	16
1.2.1	Orientation on the roller .....	16
1.2.2	Warnings .....	16
<b>2</b>	<b>Product description</b> .....	<b>19</b>
2.1	Identification of the roller .....	20
2.1.1	Machine types .....	20
2.2	Product data .....	21
2.2.1	Dimensions .....	21
2.2.2	Specifications .....	22
2.3	Roller designation .....	23
2.3.1	Identification plate .....	23
2.4	Intended use .....	24
2.4.1	Intended purpose of the ARX 1 .....	24
2.4.2	Requirements for the roller driver .....	24
2.4.3	Application limits .....	24
2.5	Inappropriate use .....	24

2.5.1	Disclaimer . . . . .	25
<b>3</b>	<b>Safety information . . . . .</b>	<b>27</b>
3.1	General work safety . . . . .	28
3.2	Roller operation . . . . .	28
3.2.1	Shear points . . . . .	29
3.3	Rollover bar (ROPS) . . . . .	30
3.4	Noise levels . . . . .	31
3.5	Safety labels on the machine . . . . .	32
3.5.1	Warning stickers . . . . .	32
3.5.2	Notice stickers . . . . .	35
3.6	Vibration hazard . . . . .	36
3.6.1	Whole-body vibrations . . . . .	36
<b>4</b>	<b>Structure and function . . . . .</b>	<b>39</b>
4.1	Component overview . . . . .	40
<b>5</b>	<b>Operating and display elements . . . . .</b>	<b>43</b>
5.1	Instrument panel . . . . .	44
5.1.1	Switch functions . . . . .	44
5.1.2	Control lamps . . . . .	45
5.1.3	Control lamp functions . . . . .	46
5.2	Error code . . . . .	49
5.2.1	Display upon start-up . . . . .	49
5.2.2	Displays during operation . . . . .	49
<b>6</b>	<b>Commissioning . . . . .</b>	<b>53</b>
6.1	Commissioning . . . . .	54
6.1.1	Roller with pneumatic wheel (combined roller) . . . . .	54
<b>7</b>	<b>Operation . . . . .</b>	<b>55</b>
7.1	Rollover bar (ROPS) . . . . .	56
7.1.1	Folding the ROPS upward . . . . .	56
7.2	Driver's seat . . . . .	57
7.2.1	Safety information . . . . .	57
7.2.2	Adjusting the driver's seat . . . . .	58
7.3	Protection against vandalism . . . . .	59
7.4	Starting the engine . . . . .	60
7.4.1	Ignition switch . . . . .	60
7.4.2	Starting the engine . . . . .	60
7.5	Driving and braking . . . . .	61
7.5.1	Setting the operating speed (vibration frequency) . . . . .	61
7.5.2	Driving . . . . .	62
7.6	Work gear / transport gear . . . . .	63
7.7	Turning off the engine . . . . .	63
7.8	Parking brake . . . . .	63
7.9	Seat switch . . . . .	63
7.9.1	Opening the seat switch . . . . .	64
7.9.2	Closing the seat switch . . . . .	64
7.10	Emergency stop . . . . .	64
7.10.1	Initiating an emergency stop . . . . .	64
7.10.2	Releasing the emergency stop . . . . .	64
7.11	Locking brake . . . . .	65
7.12	Sprinkling . . . . .	65
7.12.1	Checking water level . . . . .	65
7.12.2	Refilling with water . . . . .	65
7.12.3	Switching on continuous sprinkling . . . . .	66
7.12.4	Switch on interval sprinkling . . . . .	66



7.13	Simple/double vibration . . . . .	67
7.13.1	Vibration on / off . . . . .	67
7.14	Vibration automation . . . . .	67
7.14.1	Manual vibration . . . . .	68
7.14.2	Automatic vibration . . . . .	68
<b>8</b>	<b>Options . . . . .</b>	<b>69</b>
8.1	Edge cutter . . . . .	70
8.1.1	Presetting edge cutter . . . . .	70
8.1.2	Operation of the edge cutter . . . . .	70
8.1.3	Disks . . . . .	71
8.2	2 operating levers . . . . .	72
8.3	Rear work light and revolving warning light . . . . .	72
8.4	Revolving warning light . . . . .	73
8.4.1	Switching on the revolving warning light . . . . .	73
8.4.2	Positions of the revolving warning light . . . . .	73
8.4.3	Replacing the bulb . . . . .	74
8.5	Roof . . . . .	74
8.5.1	Transport with ROPS folded down . . . . .	74
8.5.2	Fitting / removing the roof . . . . .	74
8.5.3	Transport with ROPS folded up . . . . .	75
8.5.4	Removing the tarpaulin . . . . .	75
8.6	Reversing alarm . . . . .	75
8.7	Battery cut-off switch . . . . .	76
8.7.1	Switching battery cut-off switch on / off . . . . .	76
8.8	Anti-adhesive . . . . .	77
8.8.1	Switching on anti-adhesive . . . . .	77
8.8.2	Advantages of anti-adhesive . . . . .	78
8.8.3	Anti-adhesive designations . . . . .	78
<b>9</b>	<b>Maintenance . . . . .</b>	<b>79</b>
9.1	General safety instructions . . . . .	80
9.1.1	Battery safety instructions . . . . .	82
9.2	General information about maintenance . . . . .	82
9.3	Maintenance ARX 1 . . . . .	83
9.3.1	Maintenance plan . . . . .	83
9.4	Maintenance check sheet . . . . .	86
9.5	Towing . . . . .	87
9.6	Opening the hood . . . . .	88
9.7	Engine compartment overview . . . . .	89
9.8	Fuel (diesel) . . . . .	90
9.8.1	Checking fuel level . . . . .	90
9.8.2	Refueling . . . . .	90
9.8.3	Draining fuel . . . . .	91
9.8.4	Cleaning the fuel tank . . . . .	92
9.8.5	Fuel filter element . . . . .	92
9.8.6	Water separator filter element . . . . .	93
9.9	Engine oil . . . . .	94
9.9.1	Checking the engine oil level . . . . .	94
9.9.2	Topping up the engine oil . . . . .	94
9.9.3	Draining engine oil . . . . .	95
9.9.4	Replace the engine oil filter . . . . .	96
9.10	Hydraulic oil . . . . .	96
9.10.1	Checking the hydraulic oil level . . . . .	96
9.10.2	Topping up hydraulic oil . . . . .	96
9.10.3	Draining the hydraulic oil . . . . .	97
9.10.4	Cleaning the hydraulic oil cooler . . . . .	98
9.10.5	Replacing the hydraulic oil filter . . . . .	98

9.10.6	Replacing the ventilation filter . . . . .	99
9.11	Emptying the water tank . . . . .	100
9.11.1	Cleaning accessories . . . . .	100
9.11.2	Emptying the water tank . . . . .	100
9.12	Coolant . . . . .	100
9.12.1	Checking coolant level . . . . .	100
9.12.2	Topping up coolant . . . . .	101
9.12.3	Cleaning the radiator . . . . .	101
9.13	Functional check . . . . .	102
9.13.1	Sprinkler system . . . . .	102
9.13.2	Roller drum scraper . . . . .	102
9.13.3	Tire pressure . . . . .	103
9.13.4	Air-intake filter . . . . .	103
9.13.5	Seat contact and emergency stop . . . . .	105
9.13.6	Brakes (brake test) . . . . .	105
9.13.7	Pendulum support . . . . .	107
9.13.8	Articulated joint . . . . .	107
9.14	Lubricating steering cylinder, bearing . . . . .	107
9.15	Lubricant table . . . . .	109
9.16	Consumables . . . . .	110
9.17	Tightening torques . . . . .	110
9.18	Cleaning the roller . . . . .	111
<b>10</b>	<b>Repair . . . . .</b>	<b>113</b>
10.1	Battery . . . . .	114
10.1.1	Replacing the battery . . . . .	114
10.1.2	Starting with another battery (jumping) . . . . .	115
10.1.3	Charging the battery using a battery charger . . . . .	116
10.1.4	Long-term storage . . . . .	116
10.2	Fuses . . . . .	116
10.2.1	Engine compartment fuses . . . . .	117
10.2.2	Steering column fuses . . . . .	117
10.3	Replacing bulbs . . . . .	118
10.3.1	Replacing bulbs at the front . . . . .	118
10.3.2	Replacing bulbs at the rear . . . . .	120
10.4	Gas strut . . . . .	120
10.4.1	Replacing gas struts . . . . .	121
<b>11</b>	<b>Storage . . . . .</b>	<b>123</b>
11.1	Storage . . . . .	124
11.1.1	Short-term storage . . . . .	124
11.1.2	Long-term storage . . . . .	124
11.2	Winterization (risk of freezing) . . . . .	124
11.2.1	Draining the water tank and sprinkler . . . . .	125
11.2.2	Removing the water filter . . . . .	125
<b>12</b>	<b>Transport . . . . .</b>	<b>127</b>
12.1	Transport . . . . .	128
12.1.1	Joint protection . . . . .	128
12.1.2	Lifting at the 1-point lifting eye . . . . .	129
12.1.3	Securing the roller on the transporter . . . . .	129
12.1.4	Center of gravity . . . . .	130
<b>13</b>	<b>Disposal . . . . .</b>	<b>133</b>
13.1	Introduction . . . . .	134
13.2	Removal and depressurization of the gas struts . . . . .	134
<b>14</b>	<b>Appendix . . . . .</b>	<b>137</b>

14.1	Wiring diagram, ARX 1 .....	138
14.1.1	Key for ARX 1 wiring diagram .....	140
14.2	Hydraulics diagram, ARX 1 .....	144
14.2.1	Key for ARX 1 hydraulics diagram .....	145
14.3	Hydraulics diagram, ARX 1 K .....	146
14.3.1	Key for ARX 1 K hydraulics diagram .....	147





# General

## 1.1 About this manual

This manual is part of the customer documentation for the ARX 1 vibration roller. It is customer documentation of the Ammann Schweiz AG and its representatives in other countries.

### 1.1.1 Target audience

The target audience for this manual is the owner/operator of the ARX 4 vibration roller along with his employees who have been authorized for repair, operation and maintenance by the owner/operator.

### 1.1.2 Purpose

The purpose of this manual is to ensure the optimal use and safe application of the roller for the following processes.

- Commissioning
- Operation
- Maintenance
- Repair

### 1.1.3 Overview of customer documentation

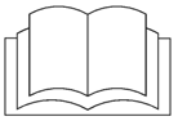

Please check that the delivery is complete and inform us within 14 days after purchase if the delivery is not complete. Please always indicate the serial number.

The customer documentation for the vibration roller and its components includes, among others, the following customer documents.

- Roller manual
- Spare parts catalog for roller
- Yanmar engine manual in English
- Yanmar engine manufacturer's declaration

Tab. 1-1 Documents for the ARX 1

Language	Manual	Spare parts catalog
Danish	1201288	
German	1201269	1214159
English	1201281	1214159
Finnish	1201292	
French	1201280	1214159
Italian	1201283	
Dutch	1201284	
Norwegian	1201287	
Polish	1201289	

Language	Manual	Spare parts catalog
Portuguese	1201291	
Russian	1201290	
Slovenian	1201285	
Spanish	1201282	
Czech	1201286	

#### 1.1.4 **Validity of the manual**

This manual is valid for the following rollers:  
ARX 12, ARX 16, ARX 16 K, ARX 20

An assortment of optional equipment is available for the roller, which we can install as you wish. For this reason, some of the figures or descriptions in this manual could deviate from your roller.

#### 1.1.5 **Storage of the manual**

Ammann Schweiz AG delivers every vibration roller with this manual. The manual is a permanent component of the roller. Store it so that it is always available for viewing by the users.

Ensure that the manual is complete and legible. If the manual should become lost, damaged or illegible, replace it promptly.

The obligation to properly store the manual for the roller covers the roller's entire service life. If you loan the roller, ensure that the manual is taken along on board the roller. If the roller is sold, hand the manual over to the new owner.

#### 1.1.6 **Technical changes**

In the interest of technical developments, Ammann Schweiz AG reserves the right to make changes to this customer document at any time without separate notice.

#### 1.1.7 **Copyrights**



The publisher of this EC compliant customer document is Ammann Schweiz AG.

We reserve all rights for this document and the roller described therein. Reproduction, disclosure to third parties or utilization of its content is forbidden without our express permission. © 2011 Ammann Schweiz AG

#### 1.1.8 **Spare parts**

In this manual, we describe selected maintenance work. We refer you to your authorized dealer for the remaining maintenance work in accordance with the maintenance plan.

When performing scheduled and unscheduled repairs, you may need to replace components of the roller.

Only use spare parts which meet the requirements specified by the Amman Schweiz AG. These requirement are fulfilled if only original Ammann spare parts are used.

For the ordering of spare parts, we provide you with a spare parts catalog.

## 1.2 Structure of the manual

The following explanations are designed to familiarize you with the roller and to provide support for handling and maintenance.

It is essential that you read chapter 3 *Safety information*, Page 27 carefully before commissioning and carrying out maintenance work.

Observing the "safety instructions" in particular increases the reliability of the roller in operation and its service life. This reduces repair costs and down time.

### 1.2.1 Orientation on the roller

When describing the components of the roller, we inform you of their position on the roller. We adhere to the orientation below when doing so.

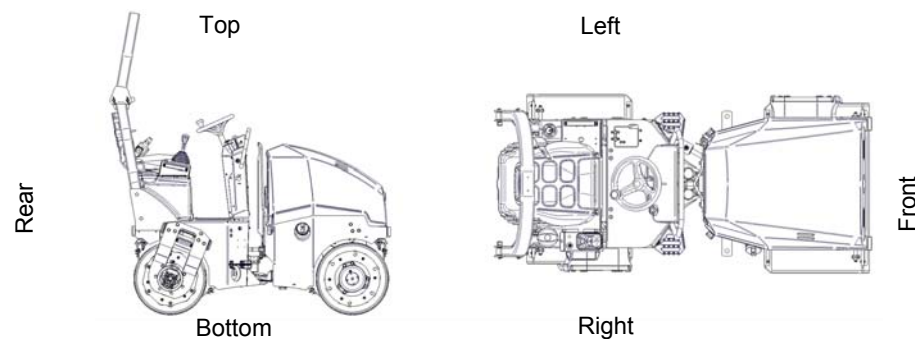

Fig. 1-1 Orientation ARX 1

We view the roller from the position of the driver in the driver's position in the direction of travel.

### 1.2.2 Warnings

Please observe the meaning of the following warnings:



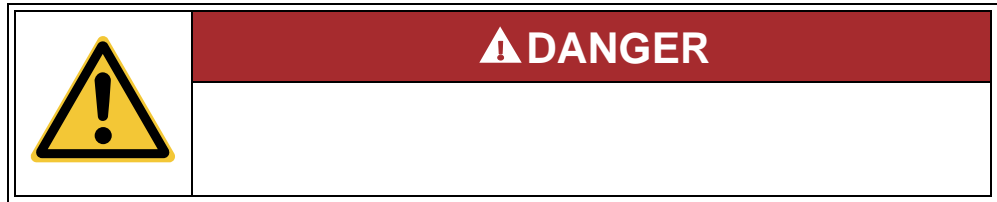

- **DANGER** represents an **immediate hazard** leading to **severe bodily injury** or **death**.

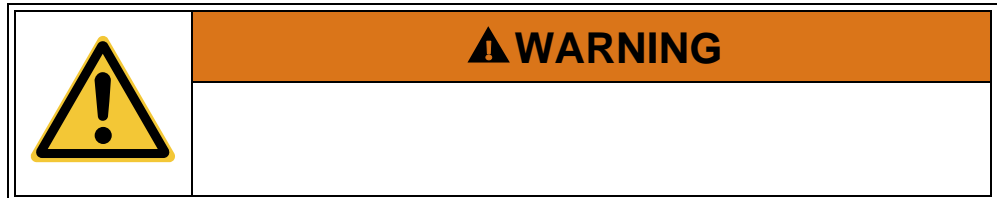

- **WARNING** represents a **possibly hazardous situation** which could lead to **severe bodily injury** or to **death**.

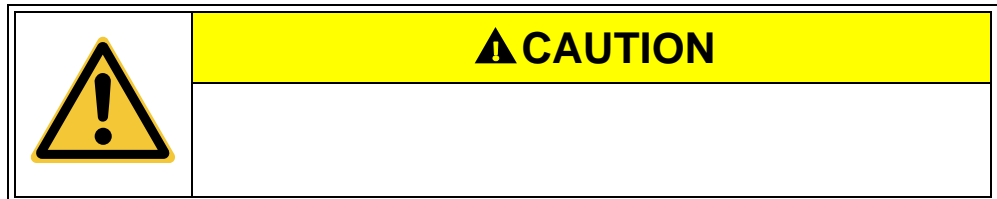

- **CAUTION** represents a **possibly hazardous situation** which could lead to **slight bodily injury**.
- Caution also represents a hazard of **environmental pollution** causing local or global environmental damage.

---

**NOTE** The battery poles and terminals must be clean. If they are coated with a (whitish or greenish) sulfur crust they must be cleaned.

---

**NOTE** Risk of cable fire or short circuit

- **NOTE** represents first of all: damage which could be caused to the roller or parts of it.
- **NOTE** represents secondly: application tips and other particularly useful information.
- **NOTE** is **not** a signal word for a hazardous or damaging situation.



**2**

# **Product description**

## 2.1 Identification of the roller

### 2.1.1 Machine types

The data given below serve to identify the models. The machine models differ only in terms of weight and the width of the roller drum. The combined roller has a pneumatic wheel axis instead of the smooth back drum roller.

ARX 12  
ARX 16  
ARX 20



Tab. 2-1 Roller with roller drum

Model	Roller drum width	Weight
ARX 12	820 mm	1475 kg
ARX 16	900 mm	1520 kg
ARX 20	1000 mm	1570 kg

ARX 16 K



Tab. 2-2 Roller with pneumatic wheel (combined roller)

Model	Roller drum width	Weight
ARX 16K	900 mm	1460 kg

**2.2 Product data**

**2.2.1 Dimensions**

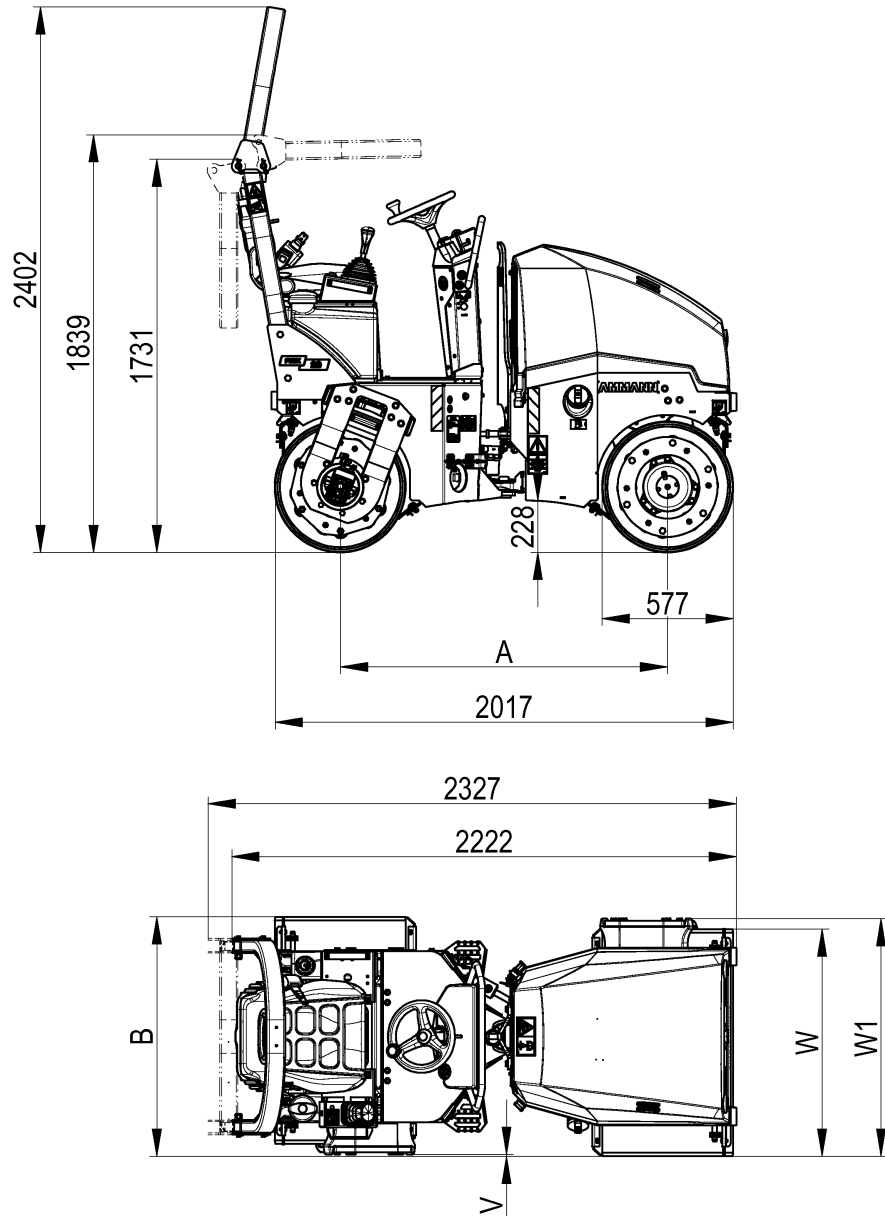

1201281 | 29.06.2012

Tab. 2-3 ARX 1 dimensions

	ARX 12	ARX 16	ARX 16 K	ARX 20
A	1440	1440	1474.5	1440
B	874	952	947	1054
W	820	900	900	1000
W1	865	947	947	1046
V	9	5	-	8

## 2.2.2

## Specifications

Tab. 2-4 ARX 1 Performance Characteristics

	ARX 12	ARX 16	ARX 16 K	ARX 20
Service weight according to CECE (kg)	1475	1520	1460	1570
Max. service weight (kg)	1700	1700	1700	1700
Static linear load (kg/cm)	9	8.4	8.4	7.9
Wheel load	-	-	183	-
Inside turning radius (mm)	2165	2125	2125	2075
Amplitude (mm)	0.5	0.5	0.5	0.45
Max. compaction force per roller drum (kN)	23	23	23	24
Gradient in % with/without vibration	30/40	30/40	30/40	30/40
Drive	YANMAR 3TNV76/Euromot 3A - EPA Inter 4			
Performance according to ISO 3046	1.) 13.3kW / 18.1HP 2.) 15.0kW / 20.4HP			
Operating speed	1.) 2100 1/min 2.) 2400 1/min			
Travel speed	0-8km/h			
Steering angle/pivoting	+/-31° / +/-5°			
Vibration frequency	1.) 58Hz 2.) 66Hz			

## Fill levels

Tab. 2-5 Fill levels ARX 1

Container	Contents
Water tank capacity	110l
Hydraulic oil tank	16l
Diesel tank	26l
Anti-adhesive tank	10l

## 2.3 Roller designation

### 2.3.1 Identification plate

An identification plate is affixed to the roller for identification. The identification plate is attached to the rear part of the chassis below the steering column.

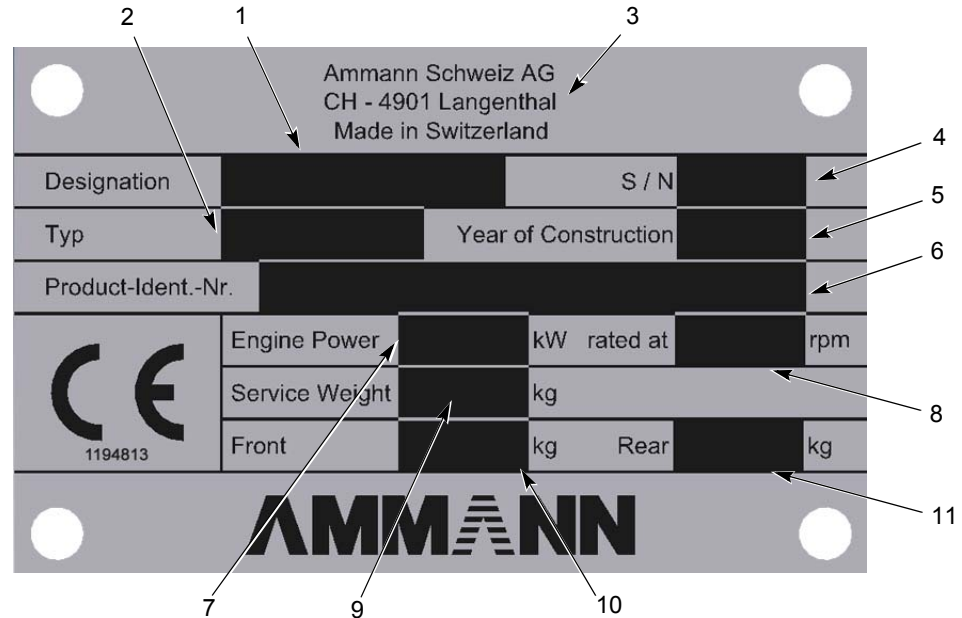

Fig. 2-1 Data on the identification plate

- 1 Roller designation
- 2 Roller model
- 3 Name and address of the manufacturer
- 4 Serial number
- 5 Year of manufacture
- 6 Vehicle Identification Number (VIN)
- 7 Fuel engine output at
- 8 Speed of fuel motor (rpm)
- 9 CECE total weight (max. weight in Switzerland)
- 10 CECE front axle weight (max. axle weight in Switzerland)
- 11 CECE rear axle weight (max. axle weight in Switzerland)

**NOTE**

**When ordering spare parts you must indicate the serial number (S/N) of the roller.**

1201281 | 29.06.2012

**2.4 Intended use**

**2.4.1 Intended purpose of the ARX 1**

ARX 1 vibration rollers are universal rollers designed for use on small and medium-sized building sites.

*Normal modes of operation* Use the ARX 1 roller exclusively for driving on and compacting:

- Unbonded layers (earth, gravel, crushed stone).
- Blacktops (asphalt).

*Special operating modes*

- Transport of the roller from A to B (crane and low loader).
- Cleaning the roller.
- Maintenance of roller according to maintenance plan or in the event of defects.
- Rectification of machine faults by trained personnel based on error messages.
- Towing the roller.
- Proper disposal by the operator in accordance with national regulations.

**2.4.2 Requirements for the roller driver**

Only trained, suitable and reliable specialists with a valid national driving license for this category of vehicle may operate the rollers.

**2.4.3 Application limits**

*Tab. 2-6 Limits for application in consideration of environmental conditions*

	Operation	Storage
Temperature limit	-10°C to +48°C	-25°C to +48°C
Humidity	All-year operation / outdoor storage	
Terrain	Level	Level
Slope up	30% with / 40% without vibration	40%
Slope down	30% with / 40% without vibration	40%

**2.5 Inappropriate use**

Inappropriate use includes any use not listed under intended use. Note the following in particular:

- The roller is not a playground.
- The roller must not be used for traction.
- The roller is not a passenger transporter.



- In the case of movements greater than 3 km, the roller must be loaded on a transporter.
- The roller is not a rock crusher, breaking chisel or similar.

### **2.5.1**      ***Disclaimer***

Ammann Schweiz AG accepts no liability for maintenance of reliable functioning of the roller if it is not used appropriately.

Unauthorized conversions and changes to the roller are prohibited for safety reasons and void any and every Ammann guarantee as well as, possibly, the CE directive.

Replaced spare or wear parts must meet the technical requirements specified by Ammann. These requirements are fulfilled if only original Ammann spare parts are used.

The instructions given in the various sections must be adhered to. The safety instructions must be observed at all times. Failure to adhere to working instructions, their correct order, safety instructions or safety labeling requirements causes liability claims to become void.



**3**

# **Safety information**

## 3.1 General work safety

- The roller may only be used for driving and compacting unbound layers (gravel, soil) and blacktops (asphalt). Other uses are prohibited.
- Rollers may only be operated with all safety devices. Manipulation or disregard of safety devices and regulations invalidates the CE conformity.
- Before starting every shift, check the effectiveness of the operation and safety devices and that the protection devices are in place.
- Check the steering and brakes when you start work. If defects are apparent roller operation is not permitted.
- If you identify any defects on the safety system or defects that impair safe operation of the equipment, inform your supervisor immediately. The roller may no longer be operated.
- If you identify any defects which endanger safe operation, cease operation immediately.
- Only perform work on and clean the roller if it is stationary and secured from rolling away.
- Switch off the engine when filling the fuel tank. Do not fill up fuel in closed rooms. No open flames.
- Do not vibrate on slopes or inclines where there is a hazard of slipping or overturning.
- Do not drive on slopes that are steeper than the maximum climbing capacity of the equipment. Always drive the roller carefully perpendicular to the slope dip.
- Do not vibrate inside buildings and on instable ground.
- Keep the driver's position and steps free of trips, grease, dirt, ice, etc.
- The driving and working field of view may not be obstructed in any way. Adjust all the necessary mirrors correctly and keep them clean.
- Switch off the engine before leaving the roller. Secure the roller from unauthorized start-up and rolling away.
- Take suitable measure to secure lowered rollers that pose an obstruction.
- Never work under the influence of drugs, alcohol or medicines that impair consciousness.
- Only operate the roller in good general light conditions and good workspace illumination.
- The operator's workplace is on the seat of the driver's platform. The roller may not be operated from any other position.

1201281 | 29.06.2012

## 3.2 Roller operation

	<b>⚠ DANGER</b>
	<p><b>Rollover hazard when driving the roller!</b></p> <ul style="list-style-type: none"> <li>• Only start the roller from the driver's position.</li> <li>• No persons may stand in front of or behind the roller while it is in operation.</li> <li>• Persons necessary for operations at the sides of the equipment must remain at a safe distance of at least 1 m.</li> </ul>

**3.2.1**

**Shear points**

- When closing the hood ensure that no objects are situated between the hood and the chassis.
- Take care that nothing is jammed in the joint plates when rotating the roller drums.
- Do not put hands between the roller drum and support during operation.

	<p><b>⚠ DANGER</b></p>
	<p><b>Danger to life through tipping or slipping of the roller! The edges of filled areas may give way!</b></p> <ul style="list-style-type: none"> <li>• Only travel directly up or down slopes.</li> <li>• Do not drive across slopes.</li> <li>• Keep your distance to embankments and edges!</li> <li>• Do not drive over steps on roadways!</li> <li>• Park the roller on slopes only in such a way that it cannot tip over.</li> <li>• Use the roller on slopes only in such a way that it cannot tip over.</li> <li>• The roller drums have very poor adhesion on snow and ice. Driving or working on a slope in snow or ice is prohibited.</li> </ul>





*Fig. 3-1 Tipping hazard!*

Construction site conditions can have a negative effect on stability and the tipping angle (e.g. height of the curb, dynamic influences).

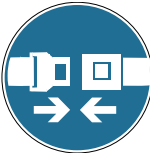
1201281 | 29.06.2012

 	<p><b>⚠ DANGER</b></p>
	<p><b>Danger to life through being thrown out!</b></p> <ul style="list-style-type: none"> <li>Always wear the safety belt. Together with the rollover bar it is a safety system that can save your life.</li> </ul> <p><b>Keep the following hazards in mind:</b></p> <ul style="list-style-type: none"> <li>Plane surfaces are not always uniformly load-bearing.</li> <li>Cavities or large stones may be located below the surface.</li> <li>Loamy/clayey soils become slippery when wet.</li> <li>Vibration can increase the hazard of lateral slipping.</li> <li>High steering angles at slope edges increase the hazard of overturning.</li> <li>Articulated machines are in particular danger from high steering angles on slopes.</li> </ul>

	<p><b>⚠ DANGER</b></p>
	<p><b>Crushing of toes through careless handling of the roller!</b></p> <ul style="list-style-type: none"> <li>Wear safety shoes when working with the roller in order to help avoid crushed toes.</li> </ul>

	<p><b>⚠ DANGER</b></p>
	<p><b>Danger of accident through improper operation of the roller!</b></p> <ul style="list-style-type: none"> <li>Read the operating instructions before operating the roller.</li> <li>Adhere to the safety regulations at all costs.</li> <li>In case of lack of clarity, contact your authorized dealer.</li> </ul>

1201281 | 29.06.2012

### 3.3 Rollover bar (ROPS)



	<p><b>⚠ DANGER</b></p>
	<p><b>Danger to life through overturning of the roller!</b></p> <ul style="list-style-type: none"> <li>Never operate the roller with the ROPS folded down!</li> </ul>



Fig. 3-2 Never fold the ROPS down during operation

	<b>⚠ WARNING</b>
	<p><b>Danger of accident due to alterations to the ROPS!</b></p> <p><b>Safety is no longer ensured if unqualified modifications or alterations are made on the ROPS.</b></p> <ul style="list-style-type: none"> <li>Do not make any modifications to the ROPS without the permission of the manufacturer.</li> </ul>



**NOTE**

Check that:

- The roller chassis is not bent or cracked in the area of the ROPS mounting.
- The ROPS has no cracks or fractures.
- All screw connections are tight (note tightening torque).

**3.4 Noise levels**



 	<b>⚠ WARNING</b>
	<p><b>Hearing damage due to continuous noise level!</b></p> <p><b>Depending on the use of equipment it is possible that the allowed noise level of 85 dB (A) will be exceeded.</b></p> <ul style="list-style-type: none"> <li>Wear ear protectors in accordance with national accident prevention regulations when working at higher noise levels.</li> </ul>

The following noise level measurements were carried out by an accredited testing and monitoring body in accordance with machine directive 2000/14/EEC of the European parliament and council.

Inspecting and monitoring organization: TÜV Österreich (Austrian technical inspectorate) Testing body no. 0408

Tab. 3-1 ARX 1 sound power level

Model	Value
Measured sound power level	ARX 1 = 99 dB (A)
Guaranteed sound power level	ARX 1 = 103 dB (A)
Measured sound pressure level at the driver's position	ARX 1 = 86.6 dB (A)

**NOTE**

The obligation to wear ear protection is standardized nationally. In Switzerland and Germany, this is as of a measured level of 85dB (A) (sound pressure).



## 3.5 Safety labels on the machine

- Observe and adhere to the rules.
- Keep the safety stickers and signs complete and legible.
- Replace any damaged or illegible stickers and signs immediately.
- You can order new stickers from Ammann Schweiz AG.

From the moment the signs are no longer recognizable and understandable at first glance, the machine must be shut down until new signs are installed.

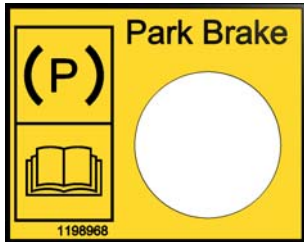

### 3.5.1 Warning stickers





Tab. 3-2 Warning stickers on board

Warning stickers	Meaning
	<p><b>Relationship to roller:</b> Operating lever console.</p> <p><b>Danger:</b> Rollover hazard!</p> <p><b>Explanation:</b> Always set the parking brake when leaving the vehicle.</p>
	<p><b>Relationship to roller:</b> Driver's position.</p> <p><b>Danger:</b> Danger of injury due to incompetent operation:</p> <p><b>Explanation:</b> Read the operating instructions before operating the roller. Adhere to the safety regulations at all costs. Contact your authorized dealer if anything is unclear.</p>

1201281 | 29.06.2012



Warning stickers	Meaning
	<p><b>Relationship to roller:</b> Between the front and rear parts of the roller.</p> <p><b>Danger:</b> Crushing hazard!</p> <p><b>Explanation:</b> Only stand in this area when necessary and only with extreme caution!</p>
	<p><b>Relationship to roller:</b> Radiator, both sides.</p> <p><b>Danger:</b> Hand injury!</p> <p><b>Explanation:</b> Do not put hands in the radiator fan when the machine is running.</p>
	<p><b>Relationship to roller:</b> Rollover bar (ROPS).</p> <p><b>Danger:</b> Crushing hazard!</p> <p><b>Explanation:</b> Never operate the roller with the ROPS folded down.</p>

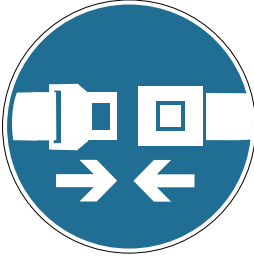

Warning stickers	Meaning
	<p><b>Relationship to roller:</b> Brake.</p> <p><b>Danger:</b> Wear of the locking brake.</p> <p><b>Explanation:</b> Only operate the parking brake when at a standstill. Only operate the emergency stop when at a standstill or in an emergency. After several operations of the locking brake while the roller is in motion, the brake test must be performed.</p>
	<p><b>Relationship to roller:</b> Safety belt</p> <p><b>Danger:</b> Risk of accident due to the roller tipping over</p> <p><b>Explanation:</b> Put on the safety belts before beginning operation of the roller.</p> <p>There is an increased risk of tipping when driving in the proximity of edges (e.g. curbstone edges, shoulders, ditches, potholes) and when driving over edges.</p>
	<p><b>Relationship to roller:</b> Driver's position.</p> <p><b>Danger:</b> Damage to electrical controls!</p> <p><b>Explanation:</b> Never spray the water jet into electrical or electronic components. Never spray into the engine combustion air intake.</p>
	<p><b>Relationship to roller:</b> Driver's position and immediate vicinity of the roller.</p> <p><b>Requirement:</b> Wear ear protectors!</p> <p><b>Explanation:</b> Wear ear protectors in accordance with national accident prevention regulations when working at higher noise levels.</p>

Warning stickers	Meaning
	<p><b>Relationship to roller:</b> Driver's position.</p> <p><b>Requirement:</b> Wear a safety belt!</p> <p><b>Explanation:</b> Always wear the safety belt when in the driver's seat.</p>

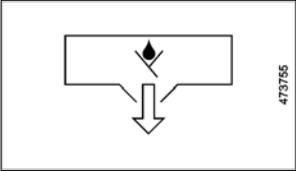

**3.5.2**

**Notice stickers**

Tab. 3-3 Notice stickers on board

Notice stickers	Meaning
	<p><b>Relationship to roller:</b> On rear chassis, front right.</p> <p><b>Designation:</b> Guaranteed sound power level.</p> <p><b>Explanation:</b> Indicates the overall noise level produced by the roller.</p>
	<p><b>Relationship to roller:</b> Front chassis, left.</p> <p><b>Designation:</b> Hydraulic oil drain.</p> <p><b>Explanation:</b> Drain hole for the hydraulic oil</p>
	<p><b>Relationship to roller:</b> Front chassis under the cooler.</p> <p><b>Designation:</b> Motor oil drain.</p> <p><b>Explanation:</b> Drain hole for the motor oil</p>
	<p><b>Relationship to roller:</b> Front chassis, right side, over the filler neck.</p> <p><b>Designation:</b> Fuel.</p> <p><b>Explanation:</b> Filler neck for diesel fuel.</p>

1201281 | 29.06.2012

Notice stickers	Meaning
 <p>410988</p>	<p><b>Relationship to roller:</b> On the four wheel supports.  <b>Designation:</b> Suspension hooks.  <b>Explanation:</b> Points on the roller at which hoisting tackle for lifting the roller can be attached.</p>
 <p>1155236</p>	<p><b>Relationship to roller:</b> On the front and rear chassis, on the left and right, respectively.  <b>Designation:</b> Tie-down point.  <b>Explanation:</b> Points on the roller at which lashing means for securing the roller on the transport vehicle can be attached.</p>

1201281 | 29.06.2012

### 3.6 Vibration hazard

#### 3.6.1 Whole-body vibrations

The acceleration data given below for the three directions were measured in accordance with Directive 2002/44/EC of the European Parliament and Council. According to this directive the following shall be taken into consideration for risk assessment:

- Extent, type and duration of exposition as well as limit values.
- All impacts on the health and safety of the roller driver.
- Information provided by the roller manufacturer.

The following represent typical ground compaction activities with and without vibration. The impact duration shall be taken into consideration when calculating the daily exposition.

Tab. 3-4 ARX 1 acceleration data in m/s<sup>2</sup> according to ISO 2631-1 for whole-body vibration

Activity	aw,eqx	aw,eqy	aw,eqz
Ground compaction with vibration	0.261	0.216	0.127
Ground compaction without vibration	0.199	0.182	0.107

Activity	VDVx	VDVy	VDVz
Ground compaction with vibration	0.35	0.90	0.87
Ground compaction without vibration	1.08	0.80	0.70

---

**NOTE**

The acceleration data are dependent on the methods used and the ground properties; that is, the values may deviate from those given.



# 4

## Structure and function

## 4.1 Component overview

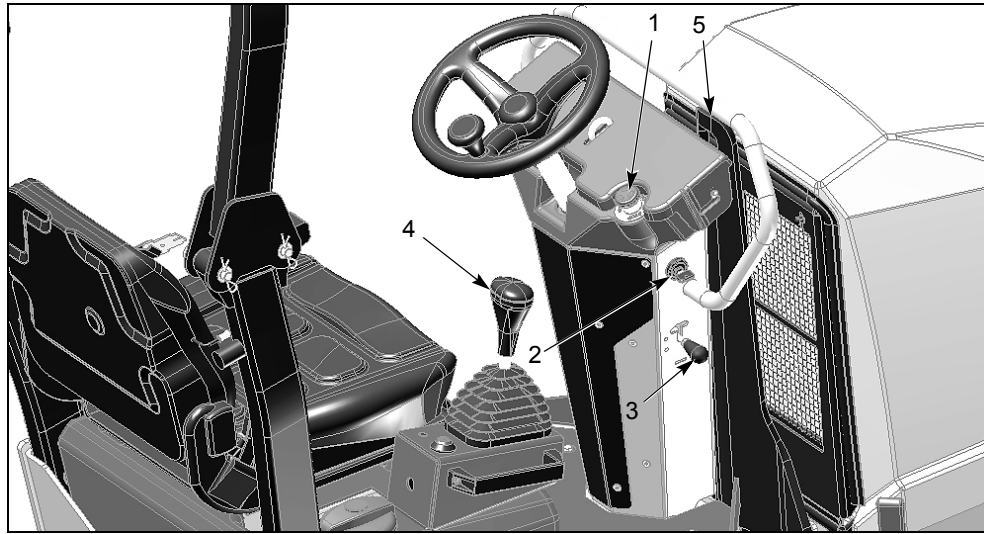

Fig. 4-1 View driver's position

- 1 Emergency stop switch
- 2 Ignition switch
- 3 Speed adjusting lever
- 4 Operating lever
- 5 Suspension

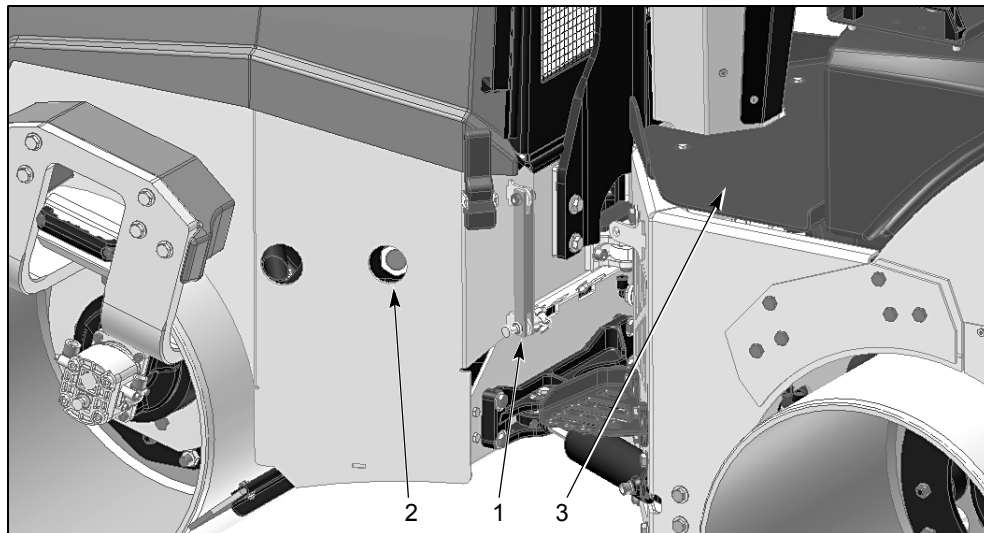
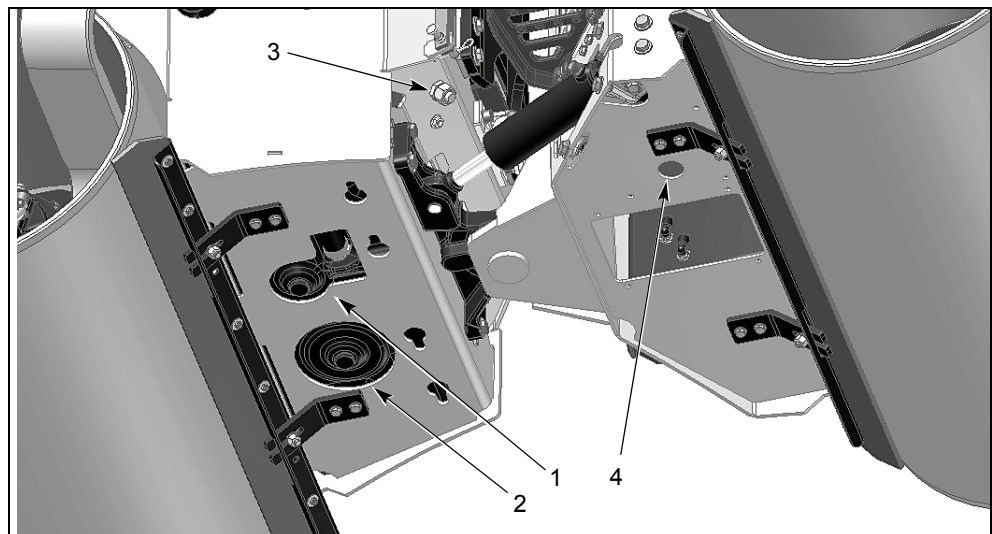

Fig. 4-2 View from left

- 1 Articulated joint protection
- 2 Hydraulic tank oil level indicator (optical)
- 3 Filler neck cover for anti-adhesive tank (option)





*Fig. 4-3 View from below*

- 1 Hydraulic oil drain
- 2 Diesel tank drain
- 3 Draining engine oil
- 4 Draining anti-adhesive tank

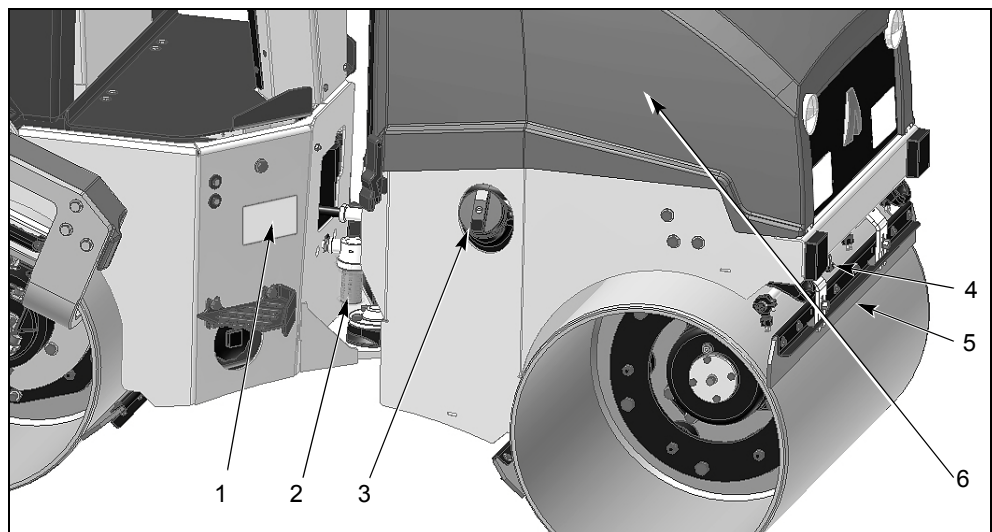

*Fig. 4-4 View front right*

- 1 Identification plate
- 2 Water filter
- 3 Tank cap (diesel)
- 4 Front sprinkler
- 5 Roller drum scraper
- 6 Document holder under the hood

1201281 | 29.06.2012

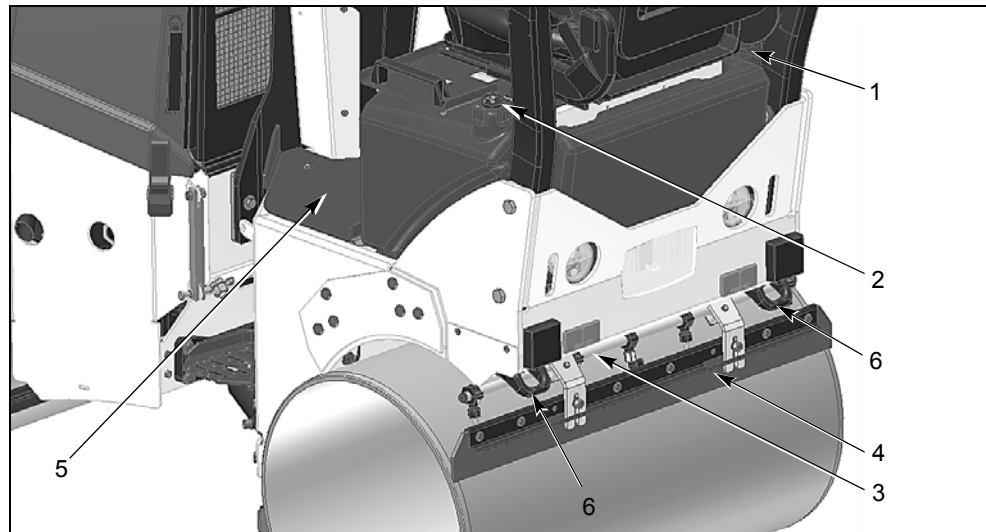

*Fig. 4-5 View rear left*

- 1 Water tank cover
- 2 Water level display
- 3 Rear sprinkler
- 4 Roller drum scraper
- 5 Water pump (below the footplate)
- 6 Towing lugs

# 5

## Operating and display elements

## 5.1 Instrument panel

### 5.1.1 Switch functions

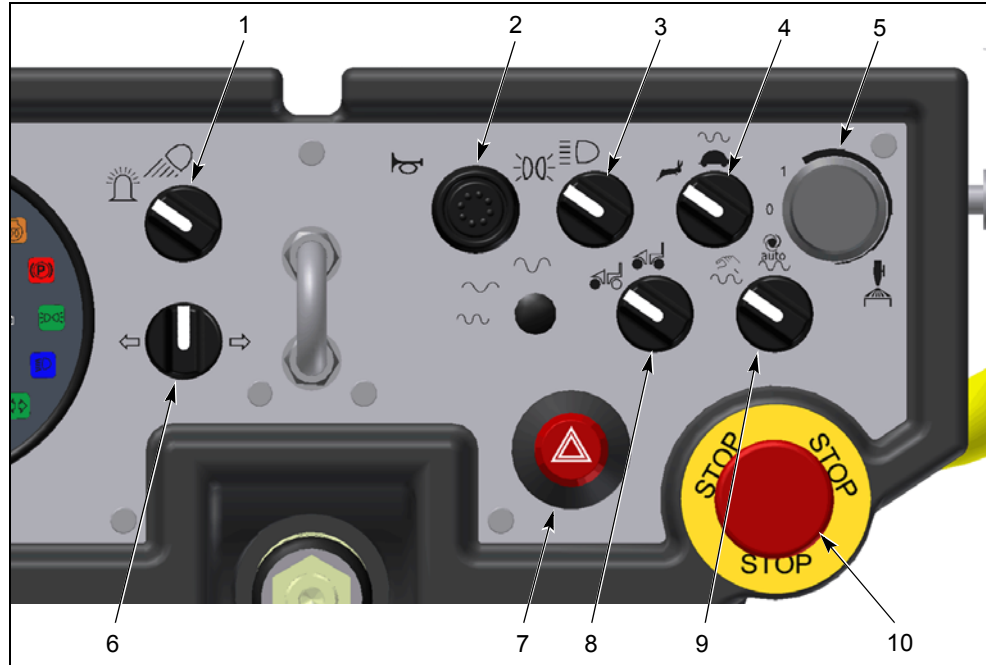

- 1 Operating switch for revolving warning light (option) and work light (option)
- 2 Horn
- 3 Operating switch for light
- 4 Operating switch for work gear / transport gear
- 5 Sprinkling interval switch
- 6 Indicator switch left / right (optional)
- 7 Operating switch for hazard flasher (optional)
- 8 Selector switch - vibration front or front and rear
- 9 Operating switch for vibration automation
- 10 Emergency stop

**5.1.2 Control lamps**



- 1 Control lamp error
- 2 Control lamp for battery charge level (charge control)
- 3 Engine oil pressure control lamp
- 4 Control lamp for engine coolant temperature
- 5 Control lamp for hydraulic oil temperature
- 6 Control lamp for emergency stop
- 7 Control lamp for diesel reserve
- 8 Control lamp for pre-heating
- 9 Brake pressure control lamp
- 10 Control lamp for parking light
- 11 Control lamp, dipped lights
- 12 Indicator control lamp
- 13 Fuel tank display
- 14 Operating hours counter
- 15 Battery voltage
- 16 Fault codes

The warning lamps for engine oil pressure, charge indicator and brake release/supply pressure must light up when the ignition is switched on. They must go off as soon as the engine is started.

1201281 | 29.06.2012

## 5.1.3 Control lamp functions

### Error



The **Error control lamp** lights as soon as the controller recognizes an error. At the same time, an error code will be shown on the display.

- 1 Check the machine based on the error code table.

If, after carrying out these checks, the battery charging lamp is still lit, call a specialist.

### Battery



If the **battery charge level control lamp** lights up during operation or does not go off after starting, carry out the following check immediately.

- 1 Stop the engine.
- 2 Check the engine for defective or loose V-belt.

If, after carrying out these checks, the battery charging lamp is still lit, call a specialist.

### Engine oil pressure



If the **engine oil pressure control lamp** lights up during operation or does not go off after starting, stop the roller and turn off the engine immediately!

- 1 Check the engine for oil loss and correct oil level.
- 2\* The oil level in the engine is correct: Call a specialist to remedy the problem.

### Coolant temperature



	<b>⚠ WARNING</b>
	<b>Danger of scalding! The cooling circuit is pressurized.</b>

### NOTE

#### **Danger of engine overheating. Stop immediately!**

If the **coolant temperature control lamp** lights up during operation of the machine, switch off the engine **immediately** and top up coolant!

- 1 Allow the engine to cool down.
- 2 Remove the radiator cap.
- 3 In order to avoid scalding, first unscrew the radiator cap one turn and allow the pressure to drop.
- 4 As soon as the pressure has dropped, remove the cap and top up the liquid.
- 5 Check the cooling system for leaks and the radiator/expansion vessel for correct coolant level.
- 6\* You are unable to find an error: Call a specialist to remedy the problem.

*Hydraulic oil temperature*



The **Hydraulic oil temperature control lamp** lights as soon as the oil temperature exceeds 85°C. As soon as the temperature exceeds 95°C, error F32 appears as well. In this condition, the machine can only be driven at 1 km/h and the vibration can no longer be switched on. The machine may only be driven normally again after the temperature has gone below 95°C.

- 1 Check the function of the hydraulic oil radiator fan.
- 2 Clean heavy soiling from the radiator body.

*Emergency stop*



If the **emergency-stop control lamp** lights up while the ignition is on, observe the following:

- 1 Release the Emergency Stop button by turning it clockwise (red mushroom button on the instrument panel).
- 2 Put the operating lever into neutral position.
- 3 Sit on the driver's seat.
- 4\* If the control lamp still continues to be lit: Call a specialist to remedy the problem.

*Diesel reserve*



After the **Diesel reserve control lamp** lights up for the first time, the fuel in the tank will last at least ½h.

- 1 Top up diesel fuel.

The tank holds 43 liters of diesel fuel.

*Pre-heating*



The pre-heating time amounts to about 15sec. When the motor is started, the **Pre-heating control lamp** goes off.

*Brake pressure*



As long as the **control lamp for brake pressure** is lit, the brake release and supply pressure of the hydraulic system is not sufficient. **As long as this control lamp is lit, the machine cannot be driven.**

- 1 Check whether the seat contact switch is closed.
- 2 Check whether errors are displayed.
- 3\* The seat contact switch is closed and the control lamp is still lit: Call a specialist to remedy the problem.

*Parking light*



The **Parking light control lamp** remains lit as long as the parking lights are switched on.

## *Dipped lights*



The **Dipped lights control lamp** remains lit as long as the dipped lights are switched on.

## *Indicators*



The **Indicator control lamp** remains lit as long as the blinker is switched on.



## 5.2 Error code

The current operating state and the errors recognized by the controller are displayed above the hour counter.

### 5.2.1 Display upon start-up

If the machine is not in operation, e.g. the seat contact is not closed, the issue preventing start-up will be displayed:

Tab. 5-1 Error code upon start-up

Display	Error	Remedy
-11	Seat contact open	Sit down
-12	Operating lever is deflected	Put the operating lever in the neutral position
-13	2 operating levers (optional), both operating levers deflected	Put the operating lever in the neutral position
-14	Parking brake is activated	Release parking brake
-15	Diesel engine is not running	Start the engine

#### NOTE

**The display remains blank when the machine is in operation, in other words, when it is being driven and/or is vibrating.**

If errors are recognized, the error warning lamp lights in addition to the display of the error code. If more than one error is present, they will be displayed one after the other at an interval of about 5sec.

### 5.2.2 Displays during operation

Tab. 5-2 Error code during operation

Display	Error	Effect	Remedy
F21	Operating lever right	Vehicle standstill. Limited driving is possible with operating lever left, if present.	Check sensor, wiring harness and connector of the RC.
F22	Move operating lever, neutral switch to right	Vehicle standstill. Limited driving is possible with operating lever left, if present.	Check sensor, wiring harness and connector of the RC.
F23	Operating lever left	Vehicle standstill. Limited driving is possible with operating lever right.	Check sensor, wiring harness and connector of the RC.
F24	Move operating lever, neutral switch to left	Vehicle standstill. Limited driving is possible with operating lever right.	Check sensor, wiring harness and connector of the RC.
F25	Sprinkler potentiometer	Sprinkler function switched off.	Check sensor, wiring harness and connector of the RC.
F26	Oil temperature sensor	Temperature control switched off.	Check sensor, wiring harness and connector of the RC.

Display	Error	Effect	Remedy
F27	PWM pump Forwards	Vehicle standstill. Driving in direction of travel backwards is possible.	Check magnet, wiring harness and connector of the RC.
F28	PWM pump backwards	Vehicle standstill. Driving in direction of travel forwards is possible.	Check magnet, wiring harness and connector of the RC.
F29	Vibration relay	Vibration is no longer actuated	Check magnet, wiring harness and connector of the RC.
F30	Brake valve	Vehicle standstill	Check magnet, wiring harness and connector of the RC.
F31	Low voltage	Vehicle standstill	Supply voltage
F32	Oil temperature too high	Driving in emergency driving mode is possible if pump has no longer been actuated.	Wait until the oil temperature sinks.
F33	Power supply, 8V	No reaction	Check supply voltage, replace controller unit.
F34	Power supply, 2.5V	Vehicle standstill. Controller central switch is opened.	Check supply voltage, replace controller unit.
F35	Ability of pump to be switched off	Vehicle standstill. Apart from the digits of the display unit, no outputs are actuated.	Check drive pump magnets, wiring harness and connector of the RC. Replace controller.
F36	PWM pump flow, forwards	Vehicle standstill.	Check drive pump magnets, wiring harness and connector of the RC. Replace controller.
F37	PWM pump flow, backwards	Vehicle standstill.	Check drive pump magnets, wiring harness and connector of the RC. Replace controller.
F38	Wrong direction of travel	Vehicle standstill.	Replace controller. Check wiring harness and connector of the RC.
F39	Current when control lever in neutral	Vehicle standstill.	Replace controller. Check wiring harness and connector of the RC.
F40	Program sequence	Vehicle standstill.	Replace controller.
F41	Starting condition	Apart from the digits of the display unit, no outputs are actuated.	Check supply voltage.
F42	Asphalt temperature sensor	No temperature display	Check sensor, wiring harness and connector of the RC.

Tab. 5-3 BUS error message

Display	Effect	Remedy
BUS	<p>No connection is present between the controller unit and the display unit. The following functions are not available:</p> <ul style="list-style-type: none"> <li>• Oil temperature warning lamp.</li> <li>• Brake pressure lamp.</li> <li>• Error warning lamp.</li> <li>• Seat contact warning buzzer.</li> <li>• Reversing alarm.</li> <li>• Sprinkler.                             <ul style="list-style-type: none"> <li>○ still available via operating lever button (not on K machines).</li> </ul> </li> <li>• Fault display.</li> </ul>	<p>Check wiring harness, display unit and controller unit.</p>

**NOTE**                      Depending on the respective error, you must turn the ignition off and then on again before once again beginning operation of the roller.



# 6

# Commissioning

## 6.1 Commissioning

### NOTE

**Familiarize yourself with the manual before commissioning.**

In order to begin operating the roller (driving), the following conditions must be fulfilled:

- Joint protection is opened.
- Motor is started.
- Seat contact is closed.
- Operating lever is in the neutral position.
- Parking brake is not activated.

In order to be able to activate the vibration, the work gear must also be activated.

### 6.1.1

#### ***Roller with pneumatic wheel (combined roller)***



- If using a combined roller, you must check tire pressure and adjust as required. The ex works pressure is set to 2.5 bar.
- Tire pressure must be adjusted to suit the compaction condition of the ground:

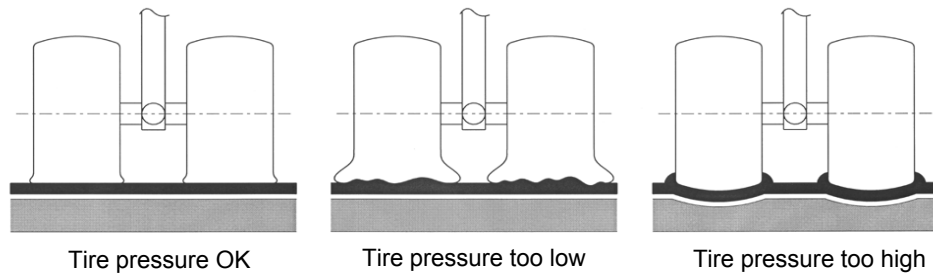

### NOTE

**The tires must be replaced if the fabric is visible on the tire surface.**



# Operation

## 7.1 Rollover bar (ROPS)

	<b>⚠ DANGER</b>
	<p><b>Danger to life through overturning of the roller!</b></p> <ul style="list-style-type: none"> <li>During operation, fold the ROPS upward.</li> <li>Fold the ROPS down only for transport.</li> </ul>

### 7.1.1 *Folding the ROPS upward*

- 1 Remove the split pin.
- 2 Remove the bolt.
  - 2.1 Place the parts on the rear water tank or on the seat. They should be easy to reach when you come to refit them.
- 3 Lift the ROPS until it remains upright alone.
- 4 Pull the ROPS all the way up.
  - 4.1 To do so, stand on the driver's position.
- 5 Fit the two bolts.
  - 5.1 You may need to use a pipe extension to help in tightening the bolts.
  - 5.2 Lubricate the bolts (e.g. Never Seez mounting grease).
- 6 Place the split pins into the bolts.



Fig. 7-1 ROPS down / ROPS up

Tab. 7-1 Torque: Threaded bolt for ROPS joint

Bolt diameter	Steel quality	Tightening torque in Nm
M18	S355	147 Nm (30 kg on 50 cm lever)

**NOTE** Both sides must be secured with bolts and split pins during operation.

1201281 | 29.06.2012





	<b>⚠ WARNING</b>
	<p><b>Danger of accident due to unsecured ROPS!</b></p> <p>The ROPS can fall as soon as it crosses its center of gravity.</p> <ul style="list-style-type: none"> <li>• Never stand below the ROPS when lowering.</li> </ul>

## 7.2 Driver's seat

### 7.2.1 Safety information

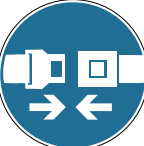
	<b>⚠ DANGER</b>
	<p><b>Danger to life through distraction!</b></p> <ul style="list-style-type: none"> <li>• Never adjust the driver's seat while driving, as you will lose control of the roller.</li> </ul>

 	<b>⚠ DANGER</b>
	<p><b>Danger to life through being thrown out!</b></p> <ul style="list-style-type: none"> <li>• Always wear the safety belt. Together with the rollover bar the safety belt is a safety system that can save your life.</li> </ul>

	<b>⚠ DANGER</b>
	<p><b>There is a risk of crushing when the roller moves out to the sides.</b></p> <ul style="list-style-type: none"> <li>• Never place your feet on the bend of the floor panel.</li> </ul>

1201281 | 29.06.2012



Fig. 7-2 Danger to foot of crushing

## 7.2.2 Adjusting the driver's seat

**NOTE** The driver's seat is important for your health. Adjust the seat to suit your body size.



Fig. 7-3 Driver's seat

- 1 Backrest
- 2 Weight
- 3 Forward/backward adjustment

*Setting  
Backrest*



- 1 Move the lever upward or downward.

The tension of the suspension can be adjusted to suit the weight of the driver.

*Setting  
Weight*



- 1 Turn the adjusting knob:
  - 2a **Toward right:** The spring tension of the seat will be reduced.
  - 2b **Toward left:** The spring tension of the seat will be increased.

Weight adjustment is infinite in the range of 50 - 120 kg.

*Forward/back-  
ward adjustment*

- 1 Pull the lever slightly upward.
  - 1.1 Place the seat in the desired position.

**NOTE**

**If adjusted ergonomically forward/backward, your feet will be on the floor panel.**

**7.3**

**Protection against vandalism**

Always fold the vandalism protection cover upward before start-up of the roller.

The vandalism protection cover protects the instrument panel from:

- the effects of weathering
- vandalism
- alterations by third parties

If you wish to secure the instrument panel from unauthorized access by third parties, you can install a padlock on the loop provided for this purpose.

Commercially available padlocks can be obtained in any building supplies store.

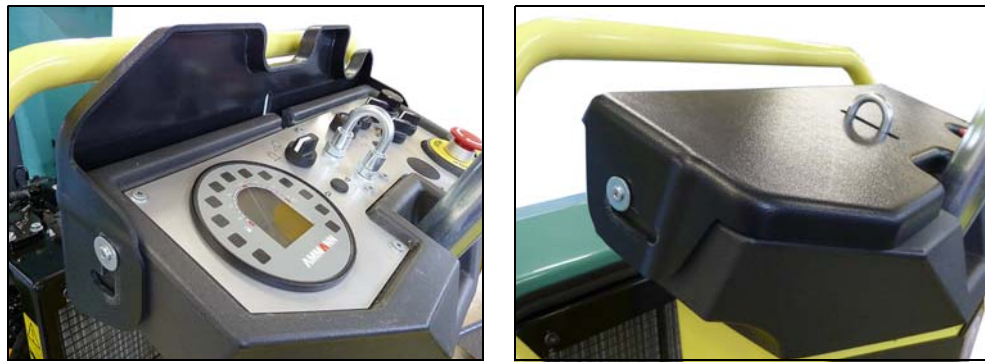

Fig. 7-4 Vandalism protection cover opened / closed

## 7.4 Starting the engine

### 7.4.1 Ignition switch



- P PARK**  
In this position you can switch on the parking light. The remaining electrical loads are off.
- 0 Off**  
All electrical loads are off.
- I Ignition on**  
All electrical consumers can be switched on.
- II Pre-heating**
- III Start**

### 7.4.2 Starting the engine

- 1 Fold the vandalism protection cover all the way back.
- 2 Move the operating lever into the neutral position until it locks in.
- 3 Put the speed adjusting lever into the idle position.
- 4 Turn the ignition key clockwise to position III.
- 5\* As soon as the engine starts up release the ignition key.



Fig. 7-5 Starting motor / position of operating lever and speed adjusting lever

**NOTE**

The control lamps for engine oil pressure, charging, hydraulic brake release/supply pressure light up when the ignition is switched on. They extinguish once the engine is running.

*Pre-heating*



If the outside temperature is below 0°C:

- 1 Turn the ignition key to position II
  - 1.1 hold it in this position for 15sec.
- 2 Turn the ignition key further to position III.

**NOTE**

When starting and driving the roller from cold, with cold hydraulic oil, braking distances are longer than when the oil has reached normal working temperature.

## 7.5 Driving and braking

### 7.5.1 *Setting the operating speed (vibration frequency)*

*Speed adjusting lever*



The roller has two operating speeds. This allows improved adaptation of speed and vibration power to specific ground conditions

- 1a **Idling speed:** Move the speed adjusting lever downward.
- 1b **Low speed:** Put the speed adjusting lever into **position I** (85%).
- 1c **High speed:** Put the speed adjusting lever into **position II** (100%).
- 2 Check whether the steering is working.

The speed influences the vibration frequency:

*Low speed:*

- low frequency
- 85 % of the vibration capacity
- 85 % of the driving speed  
(depending on the operating/transportation gear pre-select switch)
- 85 % of the diesel engine speed

*High speed:*

- high frequency
- 100 % of the vibration capacity
- 100 % of the driving speed  
(depending on the operating/transportation gear pre-select switch)
- 100 % of the diesel engine speed

1201281 | 29.06.2012

## 7.5.2 *Driving*

*Driving forwards* 1 Push the operating lever forward slowly.



The roller moves forward.

*Slowing down* 1 Slowly pull the operating lever into neutral position.



The roller is automatically hydrostatically braked.

*Driving backward* 1 Pull the operating lever back slowly.



The roller moves backward.

*Slowing down* 1 Slowly pull the operating lever into the neutral position.



The roller is automatically hydrostatically braked.

---

### NOTE

If the operating lever is released it does not automatically return to the neutral position. The lever remains at its current position.

---



### NOTE

If the operating lever is jerked over the neutral position, e.g. as a result of an emergency situation, the machine will stop.

## 7.6 Work gear / transport gear



The roller is equipped with two gears.

- 1 Turn the switch:
  - 2a **toward the left:** the hydraulic system is switched to the "transport gear" drive position. The vibration **cannot** be switched on now. The roller drives at a high speed. 
  - 2b **toward the right:** the hydraulic system is switched to the "work gear" drive position. The vibration can now be switched on as well. The roller drives at a low speed. 

## 7.7 Turning off the engine

- 1 Put the operating lever into neutral position.

The roller is automatically hydrostatically braked.

- 2 Move the speed adjusting lever downward into the idle position.
- 3 Turn the ignition key:
  - 4a **to position 0:** The engine stops.
  - 4b **to position P:** The parking lights will be switched on.

### NOTE

The hazard warning light can be switched on and off independently of the ignition key position.

## 7.8 Parking brake

*Parking brake*



All rollers are equipped with a parking brake switch. This switch activates the parking brake compulsorily. In this condition, the roller neither be moved nor can the vibration be activated. This function can be used to prevent the roller from slowly rolling on slopes.

The driver **must** activate the parking brake when leaving the roller.

### NOTE

**Increased parking brake wear.**

- The parking brake may not be activated while driving, but only when the roller is at a standstill.

## 7.9 Seat switch

The roller can only be put into operation when the seat switch is closed, i.e. the driver is seated on the driver's seat.

## 7.9.1 *Opening the seat switch*

If the seat switch is opened during operation (the driver stands up), the roller will stop after a brief delay of 0.7 sec.

---

### NOTE

The seat switch can be opened when:

- the driver leans out to the side and no longer sits on the seat with his full weight.
- the driver is too light. In this case, adjust the seat for the driver using the weight adjustment.

## 7.9.2 *Closing the seat switch*

- 1 Put the operating lever into the neutral position.
  - 1.1 You can leave the speed adjusting lever in its previous position.
- 2 Start the roller by moving the operating lever.

---

### NOTE

If the driver sits down again within the delay period, the roller continues to drive normally.

## 7.10 *Emergency stop*

If you get into an emergency situation requiring an immediate standstill of the roller, then press the emergency stop on the instrument panel.

### 7.10.1 *Initiating an emergency stop*

*Emergency stop*

- 1 Press the emergency-stop button.



The roller comes to a standstill immediately. The engine shuts down immediately and automatically. The brakes are activated.

---

### NOTE

Only press the emergency stop in an emergency.

### 7.10.2 *Releasing the emergency stop*

- 1 Put the operating lever into the neutral position.
- 2 Move the speed adjusting lever all the way back.
- 3 Now turn the emergency stop button slightly in the direction of the arrow until it clicks out.



The roller is now ready for operation.

**NOTE**

Release the emergency stop button by pulling upwards in the "pull-push" version. The direction arrows are missing from this button.

**7.11 Locking brake**

The vibration roller is equipped with an automatic locking brake.

The brakes for the drive motors work:

- When the supply pressure falls below 12 bar.
- When you activate the emergency-stop button.
  - When you press the Emergency Stop button a valve reduces supply pressure and the brakes take immediate effect.
- When you activate the parking brake.
  - When you activate the parking brake, a valve reduces the supply pressure and the brakes take immediate effect.

The locking brake closes automatically when the diesel engine is switched off.

**NOTE**

**Brake wear due to unnecessary emergency stops!**

- **In order to save the brakes from unnecessary wear, only perform an emergency stop in emergency situations when driving.**
- **Only use the locking brake in special cases, e.g. when you stop on a slope. If the roller starts to roll, move the operating lever slightly in the opposite direction, so that the vehicle is kept still hydrostatically.**

**7.12 Sprinkling**

**7.12.1 Checking water level**

Water level indicator

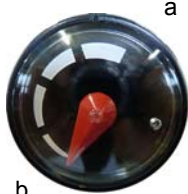

- 1 You can read the water level on the water level indicator at the rear left:
- 2a **full:** You can switch sprinkling on.
- 2b **empty:** First refill with water.

**7.12.2 Refilling with water**

- 1 Open the screw lid of the water tank at the rear right.
  - 1.1 Use the roller's ignition key to unlock the tank screw lid.
- 2 Pour water in .

1201281 | 29.06.2012



Fig. 7-6 Water tank cover rear right

### 7.12.3 Switching on continuous sprinkling

On the instrument panel 1 Turn the sprinkler switch from **Pos. 0** to **Pos. 1**.

The sprinkler switches on.



On the operating lever 1 Press the bottom button (1).

The sprinkler stays on as long as you are pressing the button.



**NOTE**

In the combined roller, operating lever sprinkling is used only for tire sprinkling.

### 7.12.4 Switch on interval sprinkling

1 Turn the sprinkler switch from **Pos. 0** to **Pos. 1**.

The sprinkler switches on.

2 Turn the switch further to the right.

The interval sprinkler switches on.

3\* Interval times: Turn the switch continuously toward the right to adjust the sprinkling intervals infinitely.



- Item 0 OFF
- Item 1 Interval sprinkler

## 7.13 Simple/double vibration

	<b>⚠ WARNING</b>
	<p><b>Danger to life through slipping or caving in of the roller!</b></p> <ul style="list-style-type: none"> <li>Do not use vibration on steep embankments or at steep angles!</li> <li>Do not vibrate inside buildings and on unstable ground!</li> </ul>

**NOTE**



**Damage to material due to harsh vibration movement.**

- Never use vibration while idling!**
- Never use vibration while at a standstill!**
- Only switch vibration on if the speed adjusting lever is set to an operating speed.**

### 7.13.1 Vibration on / off

*Presetting*



- 1 Turn the switch:
- 2a **toward left:** The roller only vibrates at the front. 
- 2b **toward right:** The roller vibrates both at the front and the rear. 

**NOTE**

**When switching from double to single vibration, there is a brief interruption of the vibration.**

*Switching on / off*



- 1 Press the top button briefly on the operating lever (1).  
Vibration switches **on**.
- 2 Press the top button again on the operating lever (1).  
Vibration switches **off**.

## 7.14 Vibration automation

In automatic mode vibration is switched on at speeds greater than 1-2 km/h and off at speeds less than 1-2 km/h.

Vibration is not possible with the roller at a standstill.

	<b>⚠ WARNING</b>
	<p><b>Unintentional reaction / accident hazard</b></p> <ul style="list-style-type: none"> <li>• If the vibration automation pre-select switch is set to automatic and vibration is activated, the roller begins to vibrate as soon as the operating lever is pushed forwards. If the driver is surprised by this reaction an uncontrolled and hazardous action may result.</li> </ul>

### 7.14.1

#### **Manual vibration**



- 1 Set the pre-select switch to the **"Manual" position** .
- 2 Press the vibration button (upper button) on the operating lever.

The roller vibrates.

### 7.14.2

#### **Automatic vibration**

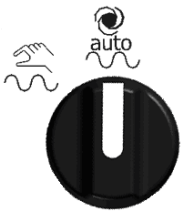

- 1 Set the pre-select switch to the **"Auto" position** .

The roller vibrates as soon as vibration is activated and the roller reaches a speed of 1-2 km/h.

The minimum speed can be changed if desired. Ask your authorized dealer.



# Options

**8.1 Edge cutter**

	<p><b>⚠ DANGER</b></p>
	<p><b>Risk of injury when lowering cutting disk or pressure disk</b></p> <ul style="list-style-type: none"> <li>Keep personnel out of the hazard zone when raising and lowering the edge cutter. Keep to a safety distance of at least 1 m.</li> </ul>



Fig. 8-1 Edge cutter / Multifunction operating lever

- 1 Raising/lowering the edge cutter
- 2 Roller drum sprinkler
- 3 Edge cutter water
- 4 Vibration on/off

**8.1.1 Presetting edge cutter**

Vibration



- 1 Before operating the edge cutter, set the pre-select switch to “front vibration”.

**NOTE**

The edge cutter only operates correctly in this setting. If the pre-select is set incorrectly, it will malfunction (vibration will be switched on, pavement will be damaged).

**8.1.2 Operation of the edge cutter**

Raise/Lower

- 1 Operation of the rocker switch (1):
- 2a **Lower:** As long as you press this switch right, the edge cutter is lowered.
- 2b **Raise:**As long as you press this switch left, the edge cutter is raised.

- Sprinkling*      1      Press the "**Sprinkler**" (2) button. The roller drum sprinkler is switched on for as long as the "Sprinkler" button is pressed.
- Water supply*      1      Pressing the "**Water**" (3) button switches on the water supply for the edge cutter.

---

**NOTE**      **The water supply only works if continuous roller drum sprinkling is switched on.**

- Vibration*      1      Press the "**Vibration**" (4) button.  
  
The vibration switches on.

---

**NOTE**      **When the vibration is switched on, the edge cutter is raised automatically. The edge cutter is nonfunctional.**

### 8.1.3      **Disks**

A **cutting disk** and a **pressure disk** are included in the edge cutter's scope of delivery.

*Cutting disk*      Using the **cutting disk (1)** the pavement can be cut at the required position or pavement edges can be straightened.

*Pressure disk*      The pavement edges are compacted at an angle using the **pressure disk (2)**.

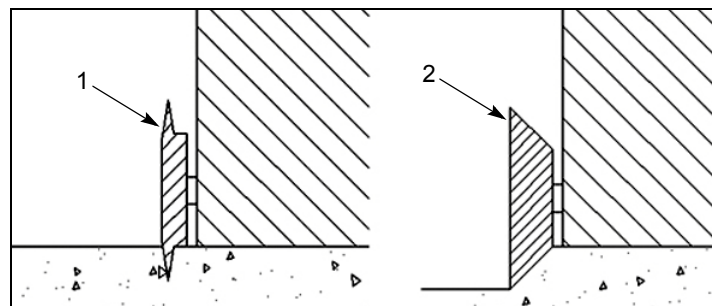



Fig. 8-2 Cutting disk and pressure disk in use

### **Storage**

If one of the two disks is not being used, fix it to the mounting provided on the left side of the roller.

	⚠ WARNING
	<p><b>Risk of injury!</b></p> <p><b>The disk can loosen and injure nearby persons!</b></p> <ul style="list-style-type: none"> <li>• Check the fastening screws when replacing the disks. Tighten the screws well on both the edge cutter and the mounting. See table 9.17, Tightening torque.</li> </ul>

## 8.2 2 operating levers



Fig. 8-3 2 operating levers

It is only possible to drive with one operating lever. The unused operating lever must be in the neutral position.

The operating buttons are always active.

- Driving with the left operating lever*
- 1 Move the right operating lever to the neutral position.
  - 2 Driving with the left operating lever

- Driving with the right operating lever*
- 1 Move the left operating lever to the neutral position.
  - 2 Driving with the right operating lever

## 8.3 Rear work light and revolving warning light

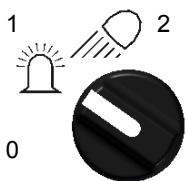

Switching the work light and the revolving warning light on and off:

- 1 Turn the switch:
- 2a **to position 0:** Both the work light and the revolving warning light are switched off.
- 2b **to position 1:** The rear revolving warning light is switched on. 



**2c to position 2:** Both the rear work light and the revolving warning light are switched on. 

**NOTE**

If the roller is no longer fitted with a revolving warning light, only the work light is lit.

**8.4 Revolving warning light**

**8.4.1 Switching on the revolving warning light**

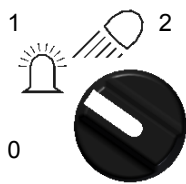

**1** Turn the switch:

**2a to position 1:** The revolving warning light is switched on. 

The roller may be fitted with a revolving warning light, but the corresponding switch may be missing. In this case the revolving warning light operates continuously as soon as the ignition key is in position II.

**8.4.2 Positions of the revolving warning light**

*in operation*

The revolving warning light is located at the rear on the rollover bar (ROPS) during operation.

*not in operation*

Fold the rollover protection (ROPS) down for transport or during extended periods of non-use.

**1** Move the driver's seat to the center.

**2** Fasten the revolving warning light to the mounting on the inner left side of the rollover bar (ROPS).

Secure the parking brake firmly.



Fig. 8-4 Revolving warning light in operation / not in operation

1201281 | 29.06.2012

## 8.4.3

### Replacing the bulb



- 1 Unscrew the theft-protection screw (1).
- 2 Lift the cover off with a twisting motion toward the right (2).
- 3 Press the two lugs of the bulb holder (3) together.
- 4 Remove the bulb from the holder.
- 5 Pull the bulb out of the connector.
- 6 Replace the defective bulb with a new one of the same type and wattage.



Fig. 8-5 Replacing the bulb

#### NOTE

**Do not touch the glass of the new bulb with your fingers. Sweat on your hands can burn into the glass and reduce bulb lifetime.**

## 8.5

### Roof



The roof option serves as all-weather protection. You can use the roof to protect from sun and rain.

#### 8.5.1

#### *Transport with ROPS folded down*

During transport with the ROPS folded down, e.g. in a container or closed truck, you must remove the whole roof.

#### 8.5.2

#### *Fitting / removing the roof*

Please note the work/assembly instructions contained in the delivery: (ANW-4397 roof option).

#### *Fitting the roof*

- 1 Screw the roof to the ROPS with the four Allen screws and washers.
  - 1.1 Make sure that the screws are always firmly tightened.

- Roof with revolving warning light*
- 1 Loosen the wing nuts of the revolving warning light.
  - 2 Lift the warning light out of the holder.

**8.5.3 Transport with ROPS folded up**

	<b>⚠ WARNING</b>
	<p><b>Material damage and hazard to road traffic</b></p> <p><b>The pressure of the head wind can cause the material to tear or come off and endanger traffic coming from behind.</b></p> <ul style="list-style-type: none"> <li>You must remove the tarpaulin during transport on an open truck.</li> </ul>

**8.5.4 Removing the tarpaulin**

- 1 Detach the hook-and-pile fastener on the sides and the leather straps in the corners.
- 2 Remove the tarpaulin.



*Fig. 8-6 Removing the tarpaulin*

**8.6 Reversing alarm**



The reverse alarm is active as soon as the roller drives backward. The alarm stays on until the roller starts to drive forward or comes to a standstill.

97dB +/- 4dB to SAE J 994, Oct. 03

	<b>⚠ DANGER</b>
	<p><b>Rollover hazard when driving the roller!</b></p> <ul style="list-style-type: none"> <li>Get out of the danger zone immediately!</li> <li>No persons may stand in front of or behind the roller while it is in operation.</li> </ul>

1201281 | 29.06.2012

## 8.7 Battery cut-off switch

The battery cut-off switch interrupts the power supply from the battery to the roller. Switch off the battery cut-off switch if the roller is not in operation for longer than two days.

---

**NOTE** Always disconnect the power supply when working on the electrical system.

### 8.7.1 Switching battery cut-off switch on / off

The battery cut-off switch is located at the rear on the battery plate.

*Switching on the power*

- 1 Turn the red key of the battery cut-off switch left to horizontal position.

If fitted, the roller is now supplied by the starter battery.



*Fig. 8-7 Switching on the power*

*Switching off the power*

- 1 Turn the red key of the battery cut-off switch down to vertical position.

This interrupts the power supply.



*Fig. 8-8 Switching off the power*

*Removing the key*

- 1 Turn the red key of the battery cut-off switch right to final position.
- 2 Now you can remove the key.
- 3 Close the keyhole using the cap provided.

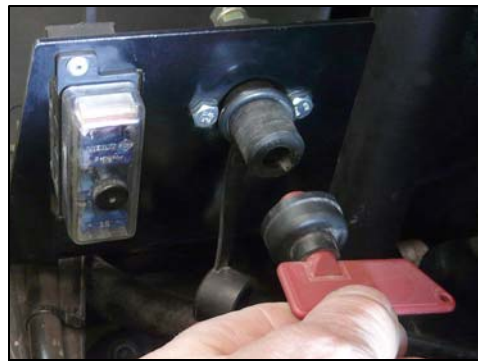

Fig. 8-9 Removing the key

## 8.8

### Anti-adhesive



Anti-adhesive is a water-soluble specialized liquid for combined rollers. The anti-adhesive ensures an effective separation between the pneumatic surfaces and the bitumen course.

The anti-adhesive tank filler neck is located on the left-hand side of the driver's position under the cover in the footplate.

Anti-adhesive reservoir volume: 12.5l

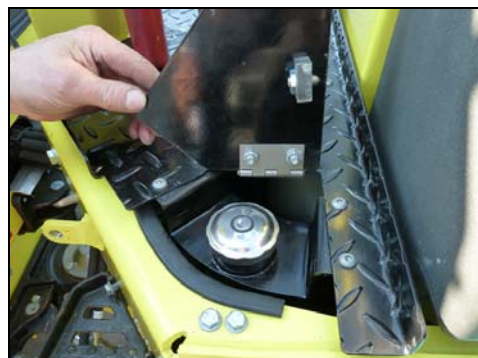

Fig. 8-10 Anti-adhesive reservoir filler neck

#### 8.8.1

#### Switching on anti-adhesive



1 Press the bottom button (1) on the operating lever.

Anti-adhesive is admixed until you release the button.

**NOTE**

The water sprinkler for the roller drum is controlled via the instrument panel.

### 8.8.2 *Advantages of anti-adhesive*

- No tearing of the course thanks to the good separating effect.
- Extremely low anti-adhesive consumption.
- The course can be worked at higher temperatures.
- Lower shocking to the course due to lower water consumption.
- Anti-adhesive does not attack the pneumatic tire rubber.
- Penetration of superfluous anti-adhesive has no subsequent negative effects.
- The anti-adhesive is **biodegradable**.

### 8.8.3 *Anti-adhesive designations*

Tab. 8-1 Anti-adhesive designations

<b>Manufacturer</b>	RHODORSIL
<b>Designation</b>	RHODORSIL EMULSION E1P
<b>Quantity</b>	25kg
<b>Mixing ratio</b>	1.5:100
<b>Part number</b>	1-951318



# Maintenance

**9.1 General safety instructions**



Maintenance **may only** be carried out by **trained personnel!**

- Only perform maintenance and repair work on the roller if it is static and secured from rolling away.
- Secure the roller with the joint protection.
- Relieve pressure before working on the hydraulic pipes.
- Disconnect the battery before commencing work on the roller's electrical systems.
  - Cover the battery with isolating material or remove it completely. This does not apply to work requiring an electric current.
  - In the event of injuries caused by acid, rinse immediately with clean water and consult a doctor.
- Replace all protection devices properly after performing maintenance and repair work.

	<b>⚠ DANGER</b>
	<p><b>Danger to life through an unsafe work area!</b></p> <ul style="list-style-type: none"> <li>• Always use an accident-proof support when working on a raised roller.</li> <li>• Never work below a roller which is only supported by a crane or other electrical / hydraulic lifting device.</li> <li>• Only stand under a raised roller if it has been mechanically secured.</li> <li>• Only use stable loading ramps suitable for the weight of the roller for loading.</li> <li>• On transport vehicles, secure the roller from rolling off, slipping to the side and tipping over.</li> </ul>

	<b>⚠ DANGER</b>
	<p><b>Gas poisoning through letting engine run in enclosed spaces!</b></p> <ul style="list-style-type: none"> <li>• Do not leave the engine running in closed areas.</li> <li>• If use of the roller in a confined space cannot be avoided, the exhaust fumes must be extracted directly from the exhaust pipe.</li> </ul>

	<b>⚠ DANGER</b>
	<p><b>Danger of scalding from hot water / steam!</b></p> <ul style="list-style-type: none"> <li>• Never remove the expansion cap or radiator cap while the engine is running or hot!</li> <li>• First loosen the cap to the first stop to release the pressure. Only then remove the cap.</li> </ul>

1201281 | 29.06.2012



	<b>⚠ DANGER</b>
	<p><b>Danger of severe injury through loose clothing being caught and drawn in!</b></p> <ul style="list-style-type: none"> <li>• Only open the engine hood when the engine is switched off.</li> <li>• If trouble shooting makes working on moving parts (engine or roller) unavoidable, <b>never</b> wear: necklaces, bracelets, rings, scarves, ties or other loose items of clothing.</li> </ul> <p>If any of these get caught in moving parts there is a danger of serious injury!</p>

	<b>⚠ WARNING</b>
	<p><b>Danger of scalding from hot water / steam!</b></p> <ul style="list-style-type: none"> <li>• Only work on a cool engine.</li> <li>• Keep enough distance to the exhaust.</li> </ul>

	<b>⚠ CAUTION</b>
	<p><b>Environmental hazard through operating materials!</b></p> <ul style="list-style-type: none"> <li>• Do not allow any liquids get into drains, soil or the environment.</li> </ul>

**NOTE**

---

**Damage to electrical controls through contact with water!**

- Never spray the water jet into electrical or electronic components.
- Never spray into the engine combustion air intake.

**NOTE**

---

**Damage to hydraulic controls through use of wrong oil!  
Hydraulic tubes decompose.**

- It is forbidden to change used rollers for use with biodegradable hydraulic oils!
- If hydraulic hoses on a roller running on synthetic ester HE need replacing, only those declared by the supplier as being compatible with synthetic esters may be used.

1201281 | 29.06.2012

**9.1.1 Battery safety instructions**

	<b>⚠ DANGER</b>
	<p><b>Risk of serious injury through leaking battery acid!</b></p> <p>The sulfuric acid in the battery is poisonous and so strong it can burn holes in clothes and dissolve skin. If it gets into eyes it can lead to blindness.</p> <ul style="list-style-type: none"> <li>• Protect the battery from fire, flames and sparks.</li> <li>• Protect the battery from mechanical damage.</li> </ul>

	<b>⚠ DANGER</b>
	<p><b>Risk of explosion when charging battery!</b></p> <ul style="list-style-type: none"> <li>• Never check the battery charge level with a metal object. Use a voltmeter or the battery's charge indicator.</li> <li>• When disconnecting the battery always disconnect the negative terminal first (-).</li> <li>• Connect the positive terminal (+) first when reconnecting.</li> </ul>

**NOTE** Doing welding work on the roller when the battery is installed can damage the electrical controls!

- Always remove the battery completely before performing welding work on the roller.

**NOTE** Always replace the battery with a service-free battery. If you are using a battery that requires maintenance, always observe the safety instructions in the battery manual.

**9.2 General information about maintenance**

**NOTE** Not all maintenance tasks are listed in these operating and maintenance instructions. We would also like to point out the separate manual for the Yanmar engine.

- When carrying out maintenance work always observe the applicable safety regulations in the 3 *Safety information*, Page 27 section.
- Maintenance work and inspections must be performed according to the following maintenance tables in order to guarantee reliable roller operation.
- Remove all dirt before taking off any covers, plugs, measuring rods, etc. to inspect or top up engine oil, hydraulic oil, diesel or other liquids.
- Any parts that do not pass the following inspections must be replaced immediately.

The protective devices must be correctly refitted after every service.

## 9.3 Maintenance ARX 1

### 9.3.1 Maintenance plan

Maintenance intervals in operating hours [h] and in calendar periods [daily, weekly, monthly, quarterly, semi annually, annually]	Check, inspect, test, correct, set up					Chapter / D = information from dealer
	Clean, drain					
	Lubricate, treat					
Exchange, replace					Object, condition	
10 1 day	50 1 week	100 1 month	250 3 months	500 6 months		
•	•					9.12
•	•					-
•			•		•	-
•				•		-
•						9.9
•					•	-
•					•	9.11
•					•	9.13.4
•						9.8
•					•	9.10
•					•	8.4.3
•					•	10.3
•					•	-
•					•	9.13.2

10 1 day	50 1 week	100 1 month	250 3 months	500 6 months	1000 1 year	as needed	Object, condition						
							(*) 1st	(*) 2nd					
	(*) 1st		(*) 2nd	•			•	Engine oil / engine oil filter	9.9.4				
	•				•		•	Brake test	9.13.6				
	•						•	Seat contact / emergency stop	9.13.5				
		•					•	Steering cylinder bearing	9.14				
			•				•	Hydraulic system leaks	-				
				(*) 1st	•		•	Hydraulic oil tank ventilation filter	9.10.6				
				(*) 1st	•		•	Hydraulic oil / hydraulic oil filter	9.10.5				
				•			•	Fuel filter element	9.8.5				
				•			•	Water separator filter element	9.8.6				
				•			•	Air filter cartridge	9.13.4				
					•			Cleaning the fuel tank	9.8.4				
					•		•	Roller drum rubber elements	D				
					•			Web plate tension sleeve thickness <17 mm	D				
					•			Hood gas strut	10.4				
							•	Fuel hoses	-				
							•	Hydraulic hoses	D				
							•	Battery	10.1				
							•	Cooling water radiator	9.12				

Object, condition		as needed								10.2
		10	50	100	250	500	1000	1000	as needed	
		1 day	1 week	1 month	3 months	6 months	1 year	1 year		
	Relays and fuses							•	•	
	Preparation for welding work							•		D
	Roller drum bearings / roller drum maintenance							•	•	D
	Hood hinges							•		D

**NOTE** Please also observe the Yanmar engine operating instructions and the detailed instructions given there.

### 9.4 Maintenance check sheet

Roller, serial no. \_\_\_\_\_

Date	Operating hours	Comments / Activity	Signature

1201281 | 29.06.2012

## 9.5 Towing



Only tow the roller in an emergency in order to move the machine away from the danger zone.

	⚠ WARNING
	<p><b>Risk of accident through improper towing!</b></p> <p><b>Adhere to the following rules:</b></p> <ul style="list-style-type: none"> <li>• Maximum towing speed: 1 km/h</li> <li>• Maximum towing distance: 10m</li> <li>• Then transport the roller by truck or trailer.</li> </ul>

1 Secure the roller with the joint protection.

1.1 See *Joint protection*, Page 128.

### Towing

1 Fasten a suitable chain, steel cable or anchor sling to the towing lugs.

2 Pull the machine out of the hazard zone.



Fig. 9-1 Tow the roller using the towing lugs

or

### Lift

1 Attach suitable equipment to the central lifting point to lift the roller out of the hazard zone.

1.1 See *Lifting at the 1-point lifting eye*, Page 129

**9.6 Opening the hood**

	<b>⚠ DANGER</b>
	<p><b>Danger of severe injury through loose clothing being caught and drawn in!</b></p> <ul style="list-style-type: none"> <li>Only open the engine hood when the engine is switched off.</li> <li>If trouble shooting makes working on moving parts (engine or roller) unavoidable, <b>never</b> wear: Necklaces, bracelets, rings, scarves, ties or other loose items of clothing. If any of these get caught in moving parts there is a danger of serious injury!</li> </ul>

	<b>⚠ WARNING</b>
	<p><b>Danger of scalding from hot water / steam!</b></p> <ul style="list-style-type: none"> <li>Only work on a cool engine.</li> <li>Keep enough distance to the exhaust.</li> </ul>

There is one locking device on the left and one on the right of the roller.

- 1 Open both catches, on the right and the left.
- 2 Open the hood with the handle on the left of the hood.
  - 2.1 Lift the hood with slight pressure toward the center of the roller.
  - 2.2\* If the hood is defective, replace it immediately.

If you wish to secure the engine compartment from unauthorized access by third parties, you can install a padlock on the loops provided for this purpose.

Commercially available padlocks can be obtained in any building supplies store.



*Fig. 9-2 Catch open / catch closed*

**NOTE**

**Two gas absorbers reduce the force required to open the hood and give it its final position. If you need more force to open the hood, replace the gas absorbers. See Gas strut, Page 120.**



## 9.7 Engine compartment overview

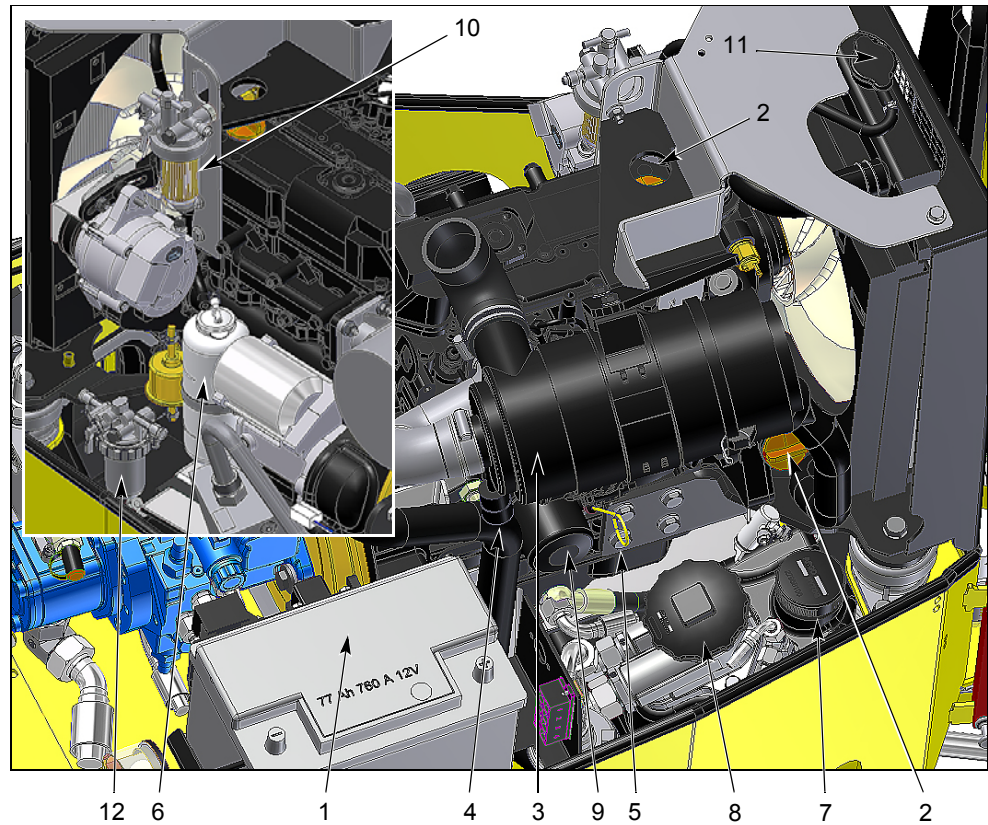



Fig. 9-3 ARX 1 engine compartment

- 1 Battery
- 2 Engine oil filler neck
- 3 Air-intake filter
- 4 Soiling indicator for air-intake filter
- 5 Oil dipstick
- 6 Coolant level display
- 7 Hydraulic oil filler neck
- 8 Hydraulic oil filter
- 9 Engine oil filter
- 10 Fuel filter
- 11 Coolant filler neck
- 12 Water separator

 	<b>⚠ WARNING</b>
	<p><b>Risk of burning and injury when handling parts in the engine compartment!</b></p> <ul style="list-style-type: none"> <li>• Switch the diesel engine off when performing any inspection work. The locking brake is active when the diesel engine is switched off.</li> </ul>

## 9.8 Fuel (diesel)

### 9.8.1 Checking fuel level

*Diesel control lamp*

After the control lamp on the instrument panel lights up for the first time, the fuel in the tank will last at least ½ h.



### 9.8.2 Refueling

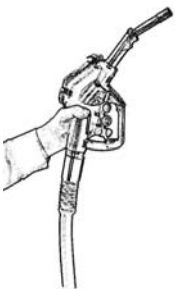

- 1 Fill the fuel tank with diesel fuel up to the lower edge of the filler neck.
  - 1a Every day before beginning work, or
  - 1b as soon as the warning lamp lights up.

The tank holds 26 liters of diesel fuel.



Fig. 9-4 Diesel fuel filler neck

**Diesel Specifications**



Tab. 9-1 Excerpt from the Yanmar engine manual about diesel specifications

Diesel specifications	Application
No. 2-D, No.1-D, ASTM D975-94	USA
EN590:96	Europe
ISO 8217 DMX	International
BS 2869-A1 or A2	Great Britain
JIS K2204 grade no. 2	Japan
KSM-2610	Korea
GB252	China

**NOTE**

**Poor quality diesel can:**

- Reduce the performance of the engine
- Damage the engine

**NOTE**

For more detailed information, please see the Yanmar engine manual.

**9.8.3**

**Draining fuel**

	<p><b>⚠ CAUTION</b></p>
	<p><b>Environmental hazard through operating materials!</b></p> <ul style="list-style-type: none"> <li>• Do not allow any liquids get into drains, soil or the environment.</li> </ul>

- 1 Unscrew the screw plug **(1)** under the roller using a square socket wrench (13mm).  
(You can find this wrench on the ratchet of the socket wrench set.)
- 2 Place a container under the drain tap.
- 3 Drain off the diesel.
- 4 Install the screw plug **(1)**.
  - 4.1 Secure the screw connections with Loctite special and tighten by hand, not with torque. Observe the table *Torque: Drain cock / hydraulic tank*, Page 111

1201281 | 29.06.2012

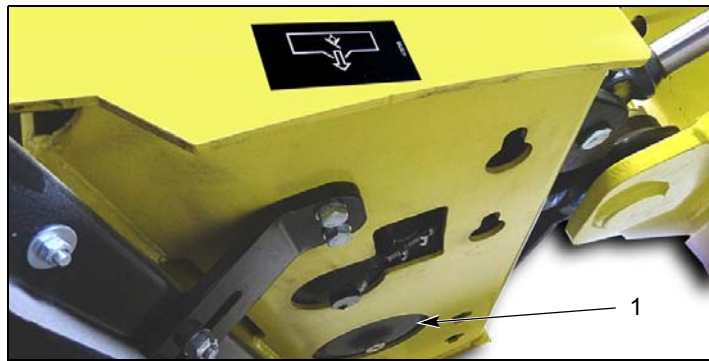

Fig. 9-5 Diesel drain

**9.8.4 Cleaning the fuel tank**

Over time, condensation water gathers in the fuel tank. It must be drained once a year.

- 1 Loosen the screw plug **(1)** beneath the roller using an open-ended wrench (size 27).
- 2 Place a container under the drain tap.
- 3 Allow about **1/2 liter** of fluid to drain.

First, the water which has collected on the bottom of the tank will run out.

- 4 Install the screw plug **(1)**.
  - 4.1 Secure the screw connections with Ergo 4207 and tighten by hand, not with torque. Observe the table *Torque: Drain cock / hydraulic tank*, Page 111

**9.8.5 Fuel filter element**



Fig. 9-6 Fuel filter

Replace fuel filter element **(1)** according to the maintenance plan.

- 1 Close stop cock **(2)**.
  - 1.1 Move to OFF.

- 2 Unscrew the filter housing (3).
- 3 Remove the old filter element (1).
- 4 Insert new filter element (1).
- 5 Screw the filter housing (3) on.
- 6 Open stop cock (2).
  - 6.1 Move to ON.

**9.8.6 Water separator filter element**



Fig. 9-7 Water separator

*Drain filter housing*

If there is water in the filter housing, the housing must be drained at once.

- 1 Close stop cock (3).
  - 1.1 Move to OFF.
- 2 Unscrew filter housing and empty.
- 3 Screw the filter housing on.
- 4 Open stop cock (3).
  - 4.1 Move to ON.

*Filter element clean*

Clean water separator element (1) according to the maintenance plan.

- 1 Close stop cock (3).
  - 1.1 Move to OFF.
- 2 Unscrew the filter housing (2).
- 3 Clean filter element (1).
- 4 Screw the filter housing (2) on.
- 5 Open stop cock (3).
  - 5.1 Move to ON.

1201281 | 29.06.2012



## 9.9 Engine oil

### 9.9.1 *Checking the engine oil level*

Oil dipstick



**1** Check engine oil level daily using the dipstick. The dipstick **(1)** is located on the left of the engine.

**1.1** Check oil level while the roller is standing on a level surface and the engine is cold.

**1.2** You can see the engine oil level on the dipstick. The oil level must be between the top **(x)** and bottom **(y)** marks.

**2\*** Top up engine oil as required.

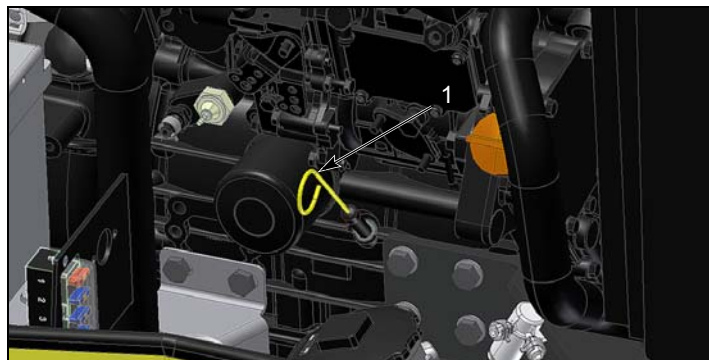

Fig. 9-8 Location of dipstick

### 9.9.2 *Topping up the engine oil*

**1** Top up the engine oil at one of the two oil filler necks.

**1a** Filler neck on the left-hand side of the engine.

**1b** Filler neck on the engine.

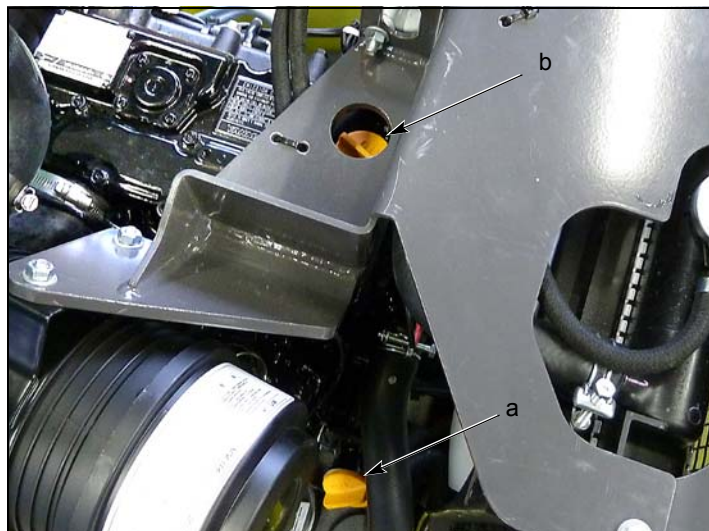

Fig. 9-9 Filler neck to the left and filler neck on top.

**NOTE**

In order to guarantee operating safety of the engine for the long term, you must not put any additives in the engine oil.

**9.9.3 Draining engine oil**

The engine oil drain is located at the front left, between the front and rear chassis.

- 1 Turn the roller all the way to the right. This provides easier access to the engine oil drain (1).

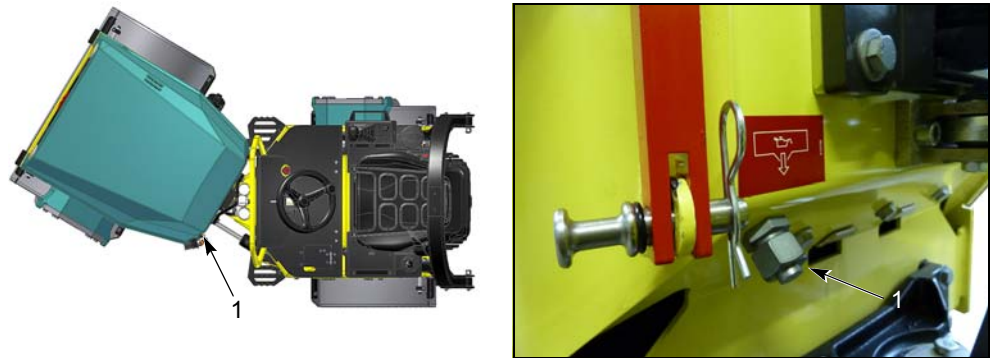



Fig. 9-10 Roller turned fully / Engine oil drain

	<p><b>⚠ CAUTION</b></p>
	<p><b>Environmental hazard through operating materials!</b></p> <ul style="list-style-type: none"> <li>• Do not allow any liquids get into drains, soil or the environment.</li> </ul>

- 2 Place a container under the drain.
- 3 Open the union by turning it anti-clockwise (27mm wrench).

The oil starts to flow out immediately.

1201281 | 29.06.2012

## 9.9.4 Replace the engine oil filter

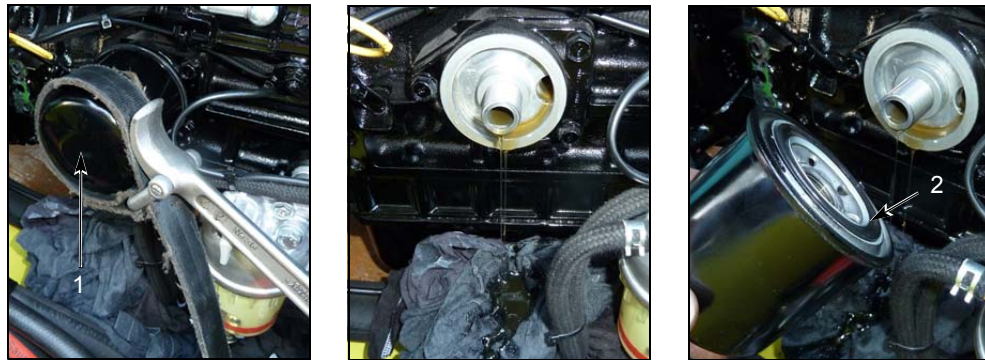

Fig. 9-11 Engine oil filter

- 1 Loosen the filter **(1)** by hand or using a filter wrench.
  - 1.1 The oil starts to flow out immediately. It's best to place a rag under it beforehand.
- 2 Replace oil filter **(2)**.
- 3 Screw the complete filter back in place.

## 9.10 Hydraulic oil

### 9.10.1 Checking the hydraulic oil level

Inspection window



Always check the hydraulic oil level at operating temperature with the engine running.

- 1 Place the roller on level ground.
- 2 Let the roller continue to idle.
- 3 Check the oil level in the inspection window.
- 4\* If oil level is in the lower third of the inspection window, top up through the filler neck with 1 liter of hydraulic oil.

### 9.10.2 Topping up hydraulic oil

- 1 Remove the screw lid on the filler neck **(1)**.
- 2 Top up with 1 liter of hydraulic oil **(2)**.
- 3 Reinstall the screw lid **(3)**.
  - 3.1 **Important:** Always grease the O-ring before screwing it in place.



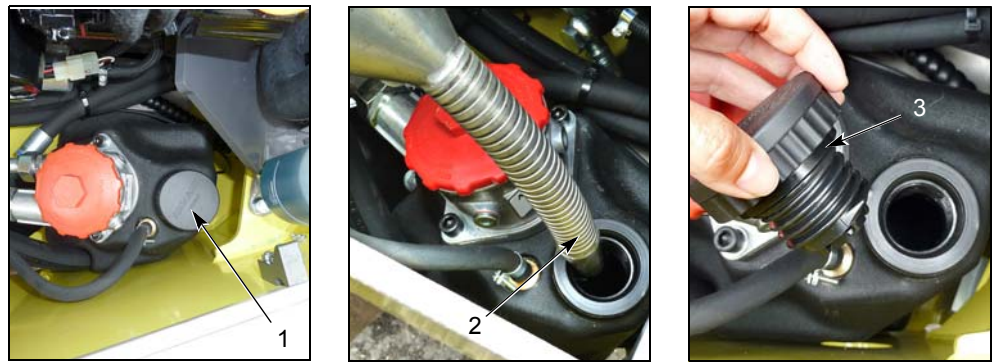

Fig. 9-12 Hydraulic oil filler neck

**NOTE** Observe the table of lubricants in chapter 9.15.

### 9.10.3 *Draining the hydraulic oil*

**NOTE** Only drain the hydraulic oil at operating temperature.

- The oil flows better.
- Residues in the tank will be flushed out with the oil.

- 1 Place a container (with at least a 30 liter capacity) under the hydraulic oil drain.
- 2 Remove the hydraulic oil tank lid.
- 3 Remove the hydraulic oil drain plug (1) under the roller.
- 4 Allow the oil to drain into the container.
- 5 Install the hydraulic oil drain plug (1).

**5.1** Secure the screw connections with Loctite special and tighten by hand, not with torque. Observe the table *Torque: Drain cock / hydraulic tank*, Page 111

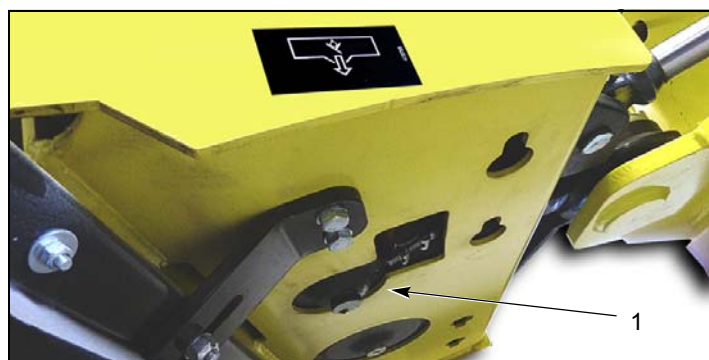

Fig. 9-13 Hydraulic oil drain

**NOTE** When you drain the hydraulic oil, please also replace the hydraulic oil filter. See chapter 9.10.5.

**NOTE** Tighten the screw connections in the hydraulic tank hand tight.

1201281 | 29.06.2012

## 9.10.4 *Cleaning the hydraulic oil cooler*

- 1 Check the cooling ribs of the hydraulic oil cooler for dirt and clogging.
- 2 Clean the ribs with water or blow them out with compressed air.

**NOTE**

Never clean the cooler with high pressure (e.g. powerful water jet).



Fig. 9-14 Hydraulic oil cooler grill

## 9.10.5 *Replacing the hydraulic oil filter*

- 1 Remove the filter lid.
- 2 Unlock the filter element.
- 3 Lift the filter element out of the filter housing.
  - 3.1 Dispose of the filter element in an ecologically appropriate manner.

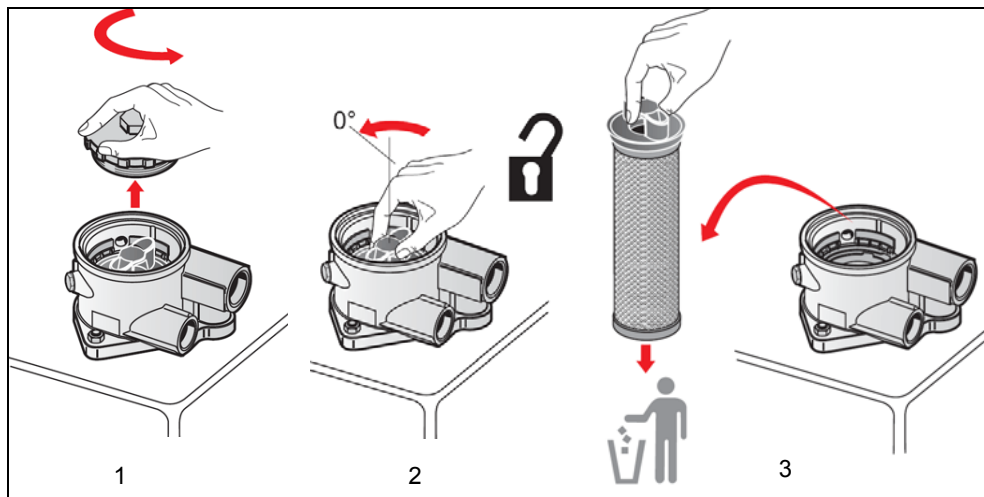

Fig. 9-15 Replacing the hydraulic oil filter, steps 1 to 3

- 4 Place the new filter element in the proper position.
  - 4.1 Observe the position of the locking cam.
- 5 Turn the filter element fully clockwise to the stop.

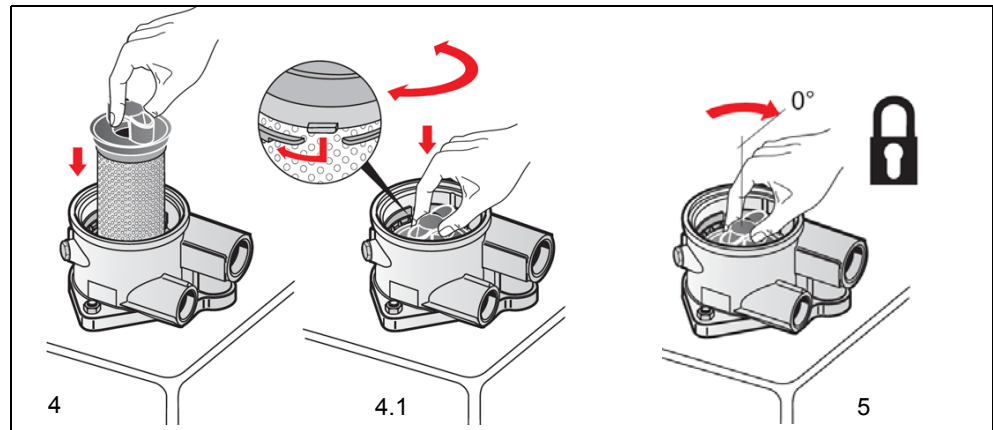

Fig. 9-16 Replacing the hydraulic oil filter, steps 4 to 6

- 6 Lightly oil the sealing ring on the filter lid.
- 7 Put the filter lid in place.
  - 7.1 Tighten the lid with a torque wrench (max. torque, 20Nm).

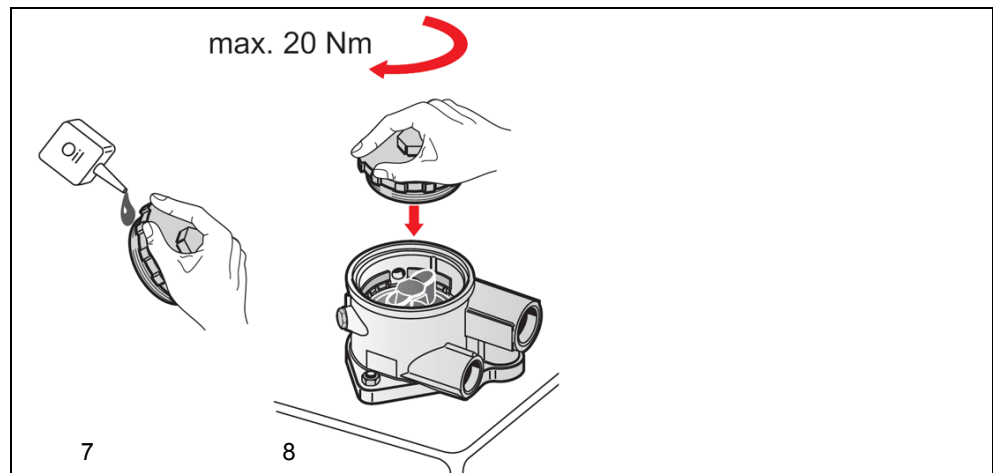

Fig. 9-17 Replacing the hydraulic oil filter, steps 7 to 8

### 9.10.6 Replacing the ventilation filter

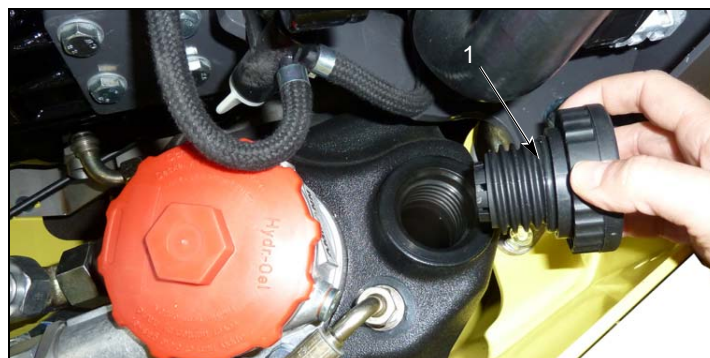

Fig. 9-18 Ventilation filter

Replace the ventilation filter **(1)** according to the maintenance plan.

## 9.11 Emptying the water tank

### 9.11.1 *Cleaning accessories*

Clean the following parts as required:

- Water tank with filler strainer
- Water filter
- Sprinkler pipes with nozzles

### 9.11.2 *Emptying the water tank*

- 1 Unscrew the screw plug (1) of the water drain with a wrench (size 32).
- 2 Drain off the water.

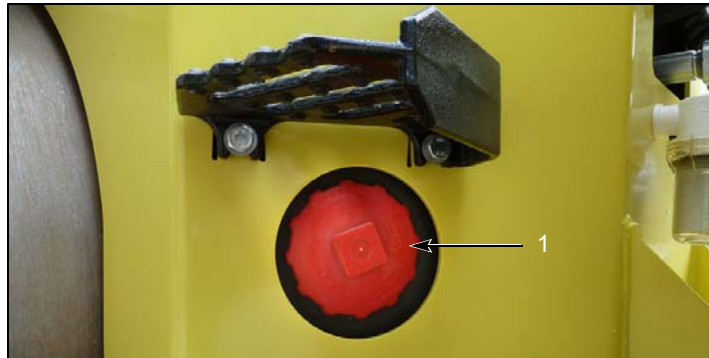

Fig. 9-19 Water drain

---

**NOTE**

In the event of the risk of frost, additionally empty the sprinkler system. See Section *Winterization (risk of freezing)*, Page 124

## 9.12 Coolant

A coolant antifreeze mixture for up to  $-25^{\circ}$  is provided upon delivery from the factory. For temperatures colder than  $-25^{\circ}$ , the fluid must be replaced by a suitable coolant antifreeze mixture.

### 9.12.1 *Checking coolant level*

- 1 Check coolant level every day.
  - 1.1 Check oil level while the roller is standing on a level surface and the engine is cold.
  - 1.2 You can read off the level of coolant on the expansion tank display. The water level must be between the top (FULL) and bottom (LOW) marks.
- 2\* Top up coolant as required.

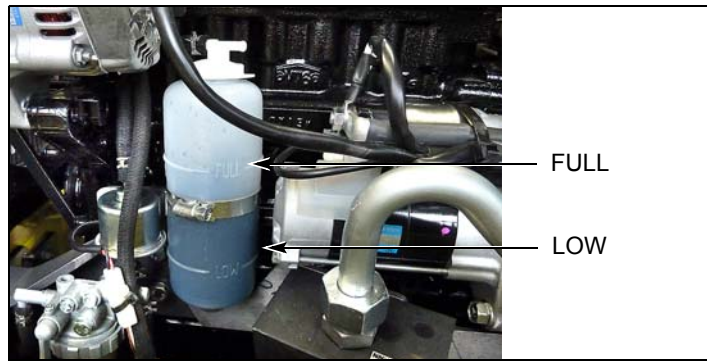

Fig. 9-20 Expansion tank

### 9.12.2 **Topping up coolant**

	<p><b>⚠ CAUTION</b></p>
<p><b>Danger of scalding from hot water / steam!</b></p> <ul style="list-style-type: none"> <li>• Only open the tank once the engine and the coolant have cooled down.</li> </ul>	

- 1 Unscrew the tank lid of the radiator.
- 2 Add coolant with antifreeze until the tank is full.



Fig. 9-21 Coolant filler neck

### 9.12.3 **Cleaning the radiator**

- 1 Check the cooling ribs of the water tank for dirt and clogging.
- 2 Clean the ribs with water or blow them out with compressed air.

**NOTE** Never clean the cooler with high pressure (e.g. powerful water jet).

1201281 | 29.06.2012





Fig. 9-22 Radiator grill

## 9.13 Functional check

### 9.13.1 Sprinkler system

- Check and adjust*
- 1 Switch on sprinkler.
  - 2 Check the nozzles on the sprinkler tubes in front and in back.

### 9.13.2 Roller drum scraper

- Roller drum scraper*
- 1 Tension the scrapers lightly by hand.

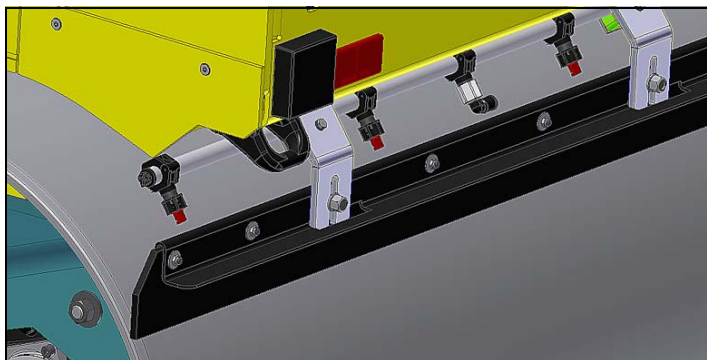

Fig. 9-23 Roller drum scraper

- Scraper for pneumatic wheels*
- 1 Adjust the scrapers with a clearance of 3-5mm.
    - 1.1 The anti-adhesive must not get scraped off.



Fig. 9-24 Clearance of scraper to pneumatic wheels

**9.13.3**

**Tire pressure**



- 1 Check the tire pressure on the pneumatic wheel axle.
- 2a = 2-2.5bar: OK.
- 2b < 2-2.5bar: Increase pressure by pumping in some air.
- 2c > 2-2.5bar: Reduce pressure by letting air out.

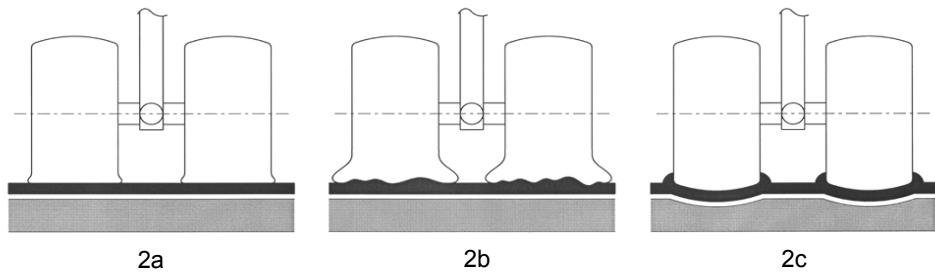

1201281 | 29.06.2012

**9.13.4**

**Air-intake filter**

*Dirt outlet*

- 1 Press the **dirt outlet** of the air-intake filter at least once a week to clean it of dirt.



Fig. 9-25 Dirt outlet

- Soiling indicator*
- 1 If a red ring appears on the soiling display **(1)** during operation of the roller, you must:
    - 2a clean the air filter cartridge,
    - 2b or replace it.



Fig. 9-26 Soiling indicator

- Air filter cartridge*
- 1 Check the air filter cartridge for:
    - 2a **Damage:** replace the cartridge.
    - 2b **Soiling:** clean the cartridge.



Fig. 9-27 Air filter cartridge

- Air intake*
- 1 Check the air intake for:
    - 2a **Damage:** replace the cowling.
    - 2b **Soiling:** clean the air intake.





Fig. 9-28 Air intake

**9.13.5 Seat contact and emergency stop**

- 1 Put the operating lever into the neutral position.
- 2 Sit on the driver's seat.
- 3 Start the engine.
  - 3.1 The brake light **(P)** must extinguish at once.
- 4 Leave the seat.
  - 4.1 After 0.7 sec., the brake light must light.
- 5 Switch off the engine.

Brake light **(P)**



**NOTE**

The emergency stop control lamp only lights when the emergency stop is pressed.

**NOTE**

The control lamp for the emergency stop circuit, operating lever neutral position and seat contact must extinguish after 2 seconds for delayed seat contact.

**9.13.6 Brakes (brake test)**

Parking brake switch



If the roller moves in spite of the actuated parking brake switch, you must perform the brake test.

- 1 Remove the brake hose from the front roller drum drive motor.
- 2 Seal the open hose end so that it can be pressurized.

1201281 | 29.06.2012

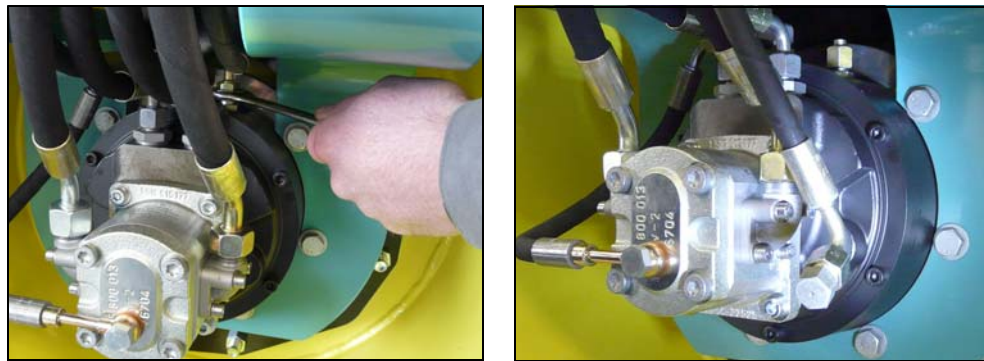

Fig. 9-29 Remove the brake hose and seal it so that it can be pressurized.

- 3 Start the roller.
- 4 Press the parking brake switch.
  - 4.1 The brake light (P) must extinguish quickly.

Brake light (P)



- 5 Test the forwards and the backwards drive.

Because the front brake remains activated, the roller does not move.

- 6 Switch the roller off.
- 7 Reinstall the brake hose.
- 8 Follow the same procedure for the rear drive motor.
- 9 Be certain that you have reconnected all brake hoses!
- 10 Start the roller.
  - 10.1 The brake light (P) must extinguish quickly.

- 11 Test the forwards and the backwards drive.

There should be no problems.

## NOTE

**Damage to property through incorrect handling!**  
**If the roller does not behave exactly as described, you have a problem with one or more brakes. The roller is no longer safe for operation.**

- **Have the roller repaired professionally.**

*Pneumatic wheel axle* If you own a roller with a pneumatic wheel axle, it is better to remove the center wheels. Please examine both motors simultaneously.

**9.13.7 Pendulum support**

Check the pendulum support once a year for excessive play.

- 1 Attach the roller to a crane (central lifting point).

The play can be checked by alternately applying and releasing upward pressure to the roller (visual inspection).



Fig. 9-30 Pendulum support

**9.13.8 Articulated joint**

Check the articulated joint once a year for excessive play.

- 1 Attach the roller to a crane (central lifting point).

The play can be checked by alternately applying and releasing upward pressure to the roller (visual inspection).



Fig. 9-31 Articulated joint



**Lubricating steering cylinder, bearing**

- 1 Rotate the roller's steering fully to the stop in order to grease the cylinder.
- 2 Steer the roller briefly to the right and the left. This causes the bearing to be unloaded.
- 3 Clean the grease nipple (1) before greasing.

- 4 Connect the grease gun to the grease nipple.
- 5 Press grease into the bearing until it visibly begins to ooze out.
- 6 Put the protective cover back on.



*Fig. 9-32 Location of grease nipples on steering cylinder*

---

**NOTE**

**Damager to property due to increased wear!**

- Regrease the bearing after every cleaning / steam cleaning of the roller.

## 9.15 Lubricant table

Tab. 9-2 Lubricant table

Brand	Hydraulic oil	Synthetic hydraulic oil based on HE esters	Grease
standard	ISO VG 46 HVLP DIN 51524 T3	ISO 15380 HEES	ISO 2137 DIN 51502
Application	Drive and vibration hydraulics	Drive and vibration hydraulics	
AGIP	Amica 46		
BLASER	Blasol 148		Foodgrease SPM00 (ARX vibro bearings)
BP	Bartran HV 46		
CASTROL	Hyspin AWH 46		
ESSO	Univis HP 46		
MOBIL	Mobil DTE15		
Motorex	Corex HV 46		Motorex 174 (ARX drive and vibro bearings)  MOLY 218 (steering cylinder)
PANOLIN	HLP Universal 46	HLP Synth 46	
SHELL	Tellus T 46		
TOTAL	Equivis ZS 46		

### NOTE

Using the wrong oil can cause damage to the hydraulic controls! Hydraulic tubes decompose.

- It is forbidden to change used rollers for use with biodegradable hydraulic oils!
- If hydraulic hoses on a roller running on synthetic ester HE need replacing, only those declared by the supplier as being compatible with synthetic esters may be used.

## 9.16 Consumables

Tab. 9-3 Consumables

Designation	Brand	Quantity	Art.no.
Engine oil	Motorex Topaz 15W50	1l	921197
Grease	Motorex Moly 218	400g	1111368
Grease	Motorex 174	4.5kg	1147048
Grease	Blaser Foodgrease SPM00	14kg	1075038
Anti-freeze	Motorex green	30l	922341
Adhesive	Loctite 4052 (blue)	50ml	1-907977
Adhesive	Loctite 4100 (red)	50ml	1-907978
Colour spray	RAL dark gray	400ml	1202234
Colour spray	RAL 1016 sulphur yellow	400ml	922700
Colour spray	RAL 6033 turquoise blue	400ml	922701
Sealant	Ergo 4207	250g	1-923054

### NOTE

The screws can loosen due to the vibration of the roller!



- Unless specified otherwise, all screws must be secured using blue thread-lock (for screws or nuts on rubber bearings: red thread-lock).

## 9.17

## Tightening torques

Tab. 9-4 Torque: hex screws and hex socket head screws (Allen)



SW hex	SW Allen	Srew diameter	Steel quality	Tightening torque in Nm
10	5	M6	8.8	10
13	6	M8	8.8	25
13	-	M8	10.9	36
15	-	M10x1.25	10.9	75
17	-	M10	8.8	48
19	10	M12	8.8	84
19	-	M12	10.9	123
19	-	M14x1.5	10.9	209
24	-	M16	8.8	206
24	-	M16	10.9	302
30	-	M20	8.8	415
30	-	M20	10.9	592

*Tab. 9-5 Torque: low-profile cylinder head screws and oval head screws*

SW Allen	Srew diameter	Steel quality	Tightening torque in Nm
3	M5	10.9	4
5	M8	10.9	10
5	M10	10.9	18

*Tab. 9-6 Torque: Shoulder screws*

SW Allen	Srew diameter	Steel quality	Tightening torque in Nm
6	M10	12.9	40

*Tab. 9-7 Torque: Countersunk head screws*

SW Allen	Srew diameter	Steel quality	Tightening torque in Nm
6	M10	12.9	40

*Tab. 9-8 Torque: Screw plugs*

SW hex	SW Allen	Srew diameter	Tightening torque in Nm
-	5	1/8"thread	13
-	10	1/2"thread	80
27	-	M22x1.5	90

*Tab. 9-9 Torque: Drain cock / hydraulic tank*

Drain cock	
Diesel tank	Secure the screw connections with ERGO 4207 and tighten by hand, not with torque.
Hydraulic tank	Secure the screw connections with ERGO 4207 and tighten by hand, not with torque.

## 9.18 Cleaning the roller

After completion of work, clean the roller:

- of major soiling;
- and the lower scrapers of deposits.

Regularly clean completely; at least once a week. When working on cohesive soils, or with cement and lime stabilizers, complete cleaning must be performed daily.

	<b>⚠ DANGER</b>
	<p><b>Danger to life through runaway roller. Persons standing in the vicinity can be rolled over!</b></p> <ul style="list-style-type: none"><li>• Before cleaning the roller, be absolutely certain to secure it against unintentional rolling away.</li></ul>

---

**NOTE**

**While cleaning, observe the following:**

- **Do not use aggressive or flammable cleansing agents (e.g. gasoline or inflammable substances).**
- **Only work with the engine turned off.**
- **Do not directly subject electrical components or isolating materials to a steam jet when using a steam cleaner. Always cover these materials.**
- **When washing the roller, ensure that no water is sprayed into the air-intake filter.**
- **Before cleaning the roller with pressure cleaners using water, steam, etc., cover all openings into which the cleaning agent may penetrate. Remove these dummy flanges after cleaning the roller.**



**10**

**Repair**

## 10.1 Battery

### NOTE

Risk of cable fire or short circuit.

Keep to the proper sequence when removing or installing the terminal connections.



The battery charge level can be read in the multifunction display unit.

- Ignition on = battery voltage. The battery voltage should not fall below 10 volts while starting, otherwise the battery must be charged.
- Machine running = alternator charging voltage. The voltage should lie in a range of from 13 to 14.5 volts.

### 10.1.1

#### Replacing the battery



- 1 Loosen the (-) terminal and disconnect it (size 13).
- 2 Loosen the (+) terminal and disconnect it (size 10).
- 3 Loosen and remove the mounting bracket.

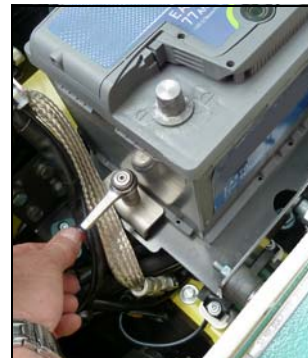

Fig. 10-1 Loosening the terminals

- 4 Lift the battery out of the engine compartment.
- 5 Set the new battery in place.
- 6 Connect the battery.
  - 6.1 Begin with the (+) terminal.



Fig. 10-2 Replacing the battery

**NOTE**

The battery poles and terminals must be clean. If they are coated with a (whitish or greenish) sulfur crust they must be cleaned.

**10.1.2**

**Starting with another battery (jumping)**



- 1 Connect the red cable to the (+) terminals of both batteries.
- 2 Connect one end of the green or black cable to the (-) terminals of both batteries.
- 3 Actuate the starter. Allow the engine to run.
- 4 Wait until the engine is idling smoothly and then disconnect the cables.

**4.1 Begin with the (-) terminal.**

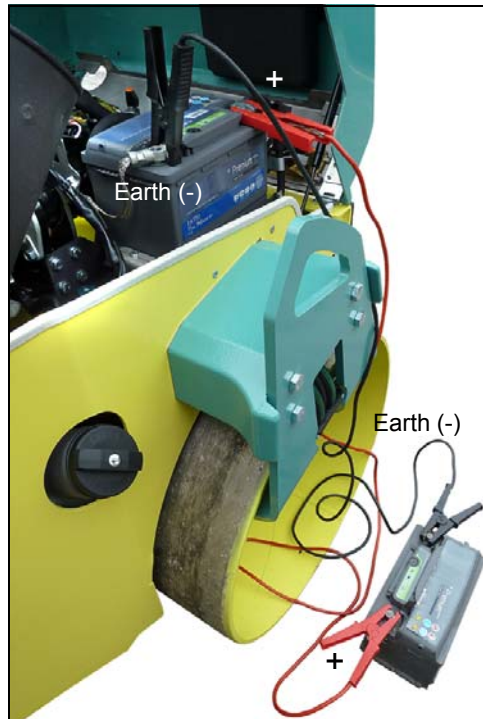

Fig. 10-3 Jumping the battery

1201281 | 29.06.2012

**NOTE**

The battery poles and terminals must be clean. If they are coated with a (whitish or greenish) sulfur crust they must be removed and cleaned.

**10.1.3**

***Charging the battery using a battery charger***



- 1 Disconnect the battery.
- 2 Connect the battery charger.
  - 2.1 Observe the battery charger manufacturer's manual.
- 3 Start with the (+) terminal when reconnecting the battery.

**NOTE**

The battery poles and terminals must be clean. If they are coated with a (whitish or greenish) sulfur crust they must be removed and cleaned.

**10.1.4**

***Long-term storage***

If the roller is not in operation for more than two days, the battery must be turned off at the battery cut-off switch. This reduces the risk of battery discharge.

If no battery cut-off switch is fitted to your roller, remove the negative battery cable from the battery if a standstill period of more than two weeks is expected.

**10.2**

**Fuses**

	<b>⚠ DANGER</b>
	<p><b>There is danger to life if the roller does not stop in hazardous situations!</b></p> <ul style="list-style-type: none"> <li>Fuses and safety switches must never be shorted.</li> </ul>

	<b>⚠ CAUTION</b>
	<p><b>Risk of injury through short circuit and cable fire when handling electrical parts!</b></p> <ul style="list-style-type: none"> <li>Always disconnect the power supply when working on the electrical system.</li> </ul>

**NOTE**

Before replacing the fuse, you must identify and remove the cause of the fault.

**10.2.1**

**Engine compartment fuses**

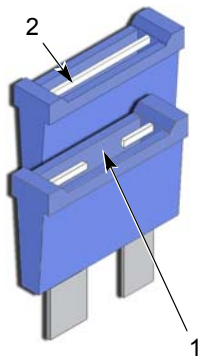

The fuses are located on the right of the engine, at the front between the engine and the water tank.

The fuse numbers are indicated on the fuse box.

Always replace a defective fuse **(1)** with a functioning fuse **(2)** of the same amperage (according to the label or color of the fuse).

Tab. 10-1 Engine compartment fuses

Fuse No.	Power	Fuse-protected circuit
F21	40 A	Pull-in solenoid
F22	15 A	Diesel pump, alternator
F23	15 A	Reserve
F24	15 A	Reserve

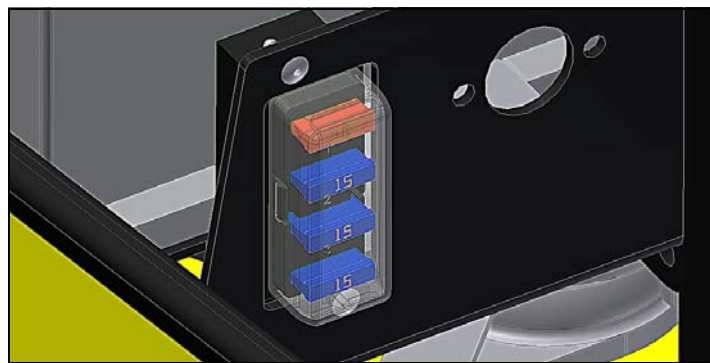

Fig. 10-4 Fuses in ARX 1 engine compartment

**10.2.2**

**Steering column fuses**

- 1 Remove the four fastening screws on the fuse box and
- 2 Remove the cover.
- 3 Replace the defective fuse.

Tab. 10-2 Steering column fuses

Fuse No.	Power	Fuse-protected circuit
F1	10 A	Hazard warning light
F2	7.5 A	Parking light, front right, rear left
F3	7.5 A	Parking light, front left, rear right
F4	10 A	Dipped light
F5	15 A	Revolving warning light, work light
F6	5 A	Horn
F7	10 A	Display unit, blinker, reverse alarm

1201281 | 29.06.2012

Fuse No.	Power	Fuse-protected circuit
F8	10 A	Seat heating
F9	3 A	Controller
F10	10 A	Controller, drive pump, brake valve, holding solenoid
F11	15 A	Sprinkling
F12	10 A	Flow divider, edge cutter
F13	10 A	Vibro switch valve
F14	1 A	Brake pressure switch
F15	25 A	Fuse, hydraulic oil cooler
F16	15 A	Reserve

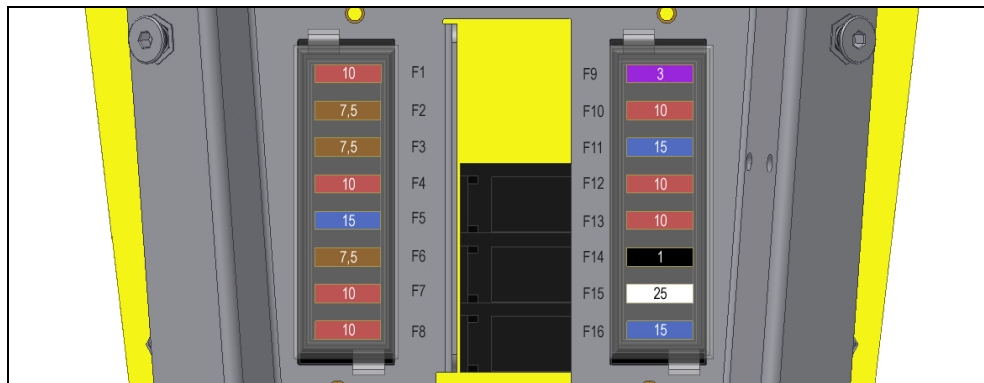

Fig. 10-5 Position of fuses in the steering column

1201281 | 29.06.2012

## NOTE

Faulty installation can cause short circuiting or a cable fire.

- When replacing fuses, do not mix them up.

## 10.3 Replacing bulbs

### 10.3.1 Replacing bulbs at the front

- 1 Open the hood, see *Opening the hood*, Page 88..

The bulbs of the low beam lights **(1)** and the parking lights **(2)** are now accessible.



Fig. 10-6 Dipped lights and parking lights:

- Dipped light*
- 1 Remove the plug from the rear of the lamp unit.
  - 2 Remove the guard.
  - 3 Press on the end of the securing clip to remove it.
  - 4 Replace the defective bulb with a new one of the same type and power.
  - 5 Put the guard back on the casing.

**NOTE**

**The guard must sit firmly on the glass body of the low beam headlight unit in order to prevent water from entering.**

- Parking light*
- 1 Pull the bulb out of the lamp holder.
  - 2 Replace the defective bulb with a new one of the same type and power.

- Position light*
- 1 Remove the lamp housing of the position light **(1)**.
    - 1.1 To do so, undo the screw in the center of the housing.
  - 2 Replace the defective bulb with a new one of the same type and power.

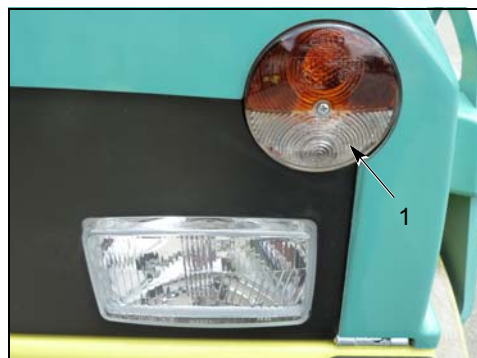

Fig. 10-7 Position light

**NOTE**

**Do not touch the glass of the new bulb with your fingers. Sweat on your hands can burn into the glass and reduce bulb lifetime.**

1201281 | 29.06.2012

## 10.3.2 Replacing bulbs at the rear

At the rear, you have direct access to the work light **(1)** and the tail lights **(2)**.



Fig. 10-8 Work light / tail light

### Work light

- 1 Remove the entire work light from the water tank.
- 2 Remove the plug from the rear of the lamp unit.
- 3 Remove the guard.
- 4 Press on the end of the securing clip to remove it.
- 5 Replace the defective bulb with a new one of the same type and power.
- 6 Put the guard back on the casing.

### NOTE

The guard must sit firmly on the glass body of the low beam headlight unit in order to prevent water from entering.

### Tail light

- 1 Remove the lamp housing.
  - 1.1 To do so, undo the screw in the center of the housing.
- 2 Replace the defective bulb with a new one of the same type and power.

## 10.4

### Gas strut



Gas struts are maintenance-free! They require no maintenance such as lubrication. They are designed for the respective requirements and work trouble-free for many years.



**10.4.1 Replacing gas struts**

	<p><b>⚠ WARNING</b></p>
	<p><b>Risk of accident through hood falling down!</b></p> <ul style="list-style-type: none"> <li>• Secure the hood before you replace the gas struts.                     <ul style="list-style-type: none"> <li>○ Support the hood with a rod.</li> <li>○ Attach the hood to a crane by the handle.</li> </ul> </li> </ul>

*removal*



- 1 Use a screwdriver to lift the clips.
- 2 Pull the gas strut away from the ball joint.



*Fig. 10-9 Using a screwdriver, lift the clips and loosen the springs*

*installing*

- 1 The new gas struts can easily be installed by pressing them onto the ball joint.
  - 1.1 The rod must face downward.

**NOTE**

**Gas struts should not be installed if they have been damaged through mechanical manipulation.**

- Welding on gas struts as well as dirt or paint on the piston rods can lead to failure of the units.
- Avoid modifications, manipulation, impacts, tensile loading, heating, painting over or removal of imprints.
- Do not install defective or improperly handled products.

**NOTE**

**If gas struts are no longer needed, they must be disposed of in an environmentally appropriate manner. For this purpose, they will be drilled out to allow the compressed nitrogen to escape and to drain the oil they contain. See also *Removal and depressurization of the gas struts*, Page 134**

1201281 | 29.06.2012





# Storage

## 11.1 Storage

### 11.1.1 Short-term storage

- Put the operating lever into neutral position.
- Secure the roller from unauthorized start-up and unintentional rolling away.
- Remove the ignition key.

### 11.1.2 Long-term storage

Tab. 11-1 Long-term storage

defective components	precautions	Chapter
Diesel engine	Observe the information in the “Long-term storage” section in the diesel engine manual.	
Fuel (diesel)	Drain.	9.8.3
Battery cut-off switch	If the roller is not in operation for more than two days, the battery must be turned off at the battery cut-off switch. This reduces the risk of battery discharge.  If no battery cut-off switch is fitted to your roller, remove the negative battery cable from the battery if a standstill period of more than two weeks is expected.	8.7
Battery	Uninstall the battery and clean the outside. Charge the battery once a month during standstill time.	10.1
Air filter unit, exhaust pipe	Cover the air filter unit or its intake opening and the exhaust pipe with adhesive tape. This prevents moisture from getting into the engine.	
Hydraulic oil level	Drain the hydraulic oil completely. Fill up the hydraulic oil tank with fresh oil when putting the machine back into operation.	9.10
Steering cylinder	Lubricate the bearings of the steering knuckle and the front bearing of the steering cylinder with grease.  Lubricate the piston rod of the steering cylinder with grease guard.	9.14
Tires	Only combined rollers have tires. Relieve the pressure in tires (pneumatic wheels) if the machine is not being used for a prolonged period by relieving the pneumatic wheel axis with a wooden wedge so as to avoid flat spotting damage to the tires.	

1201281 | 29.06.2012

## 11.2 Winterization (risk of freezing)



The purpose of winterization is to ensure that cold air temperatures of below 0 °C do not damage the sprinkler system.

**11.2.1 Draining the water tank and sprinkler**

The water tank and the sprinkler unit must be drained.

- 1 Undo the quick-release coupling of the sprinkler hose.
  - 1.1 Press the black plastic ring against the screw connection.
- 2 Pull the hose off the coupling.
- 3 Drain off the water.
- 4 Switch on sprinkler.
- 5 Let the water pump run briefly.
  - 5.1 This pumps the remaining water out of the pipes.

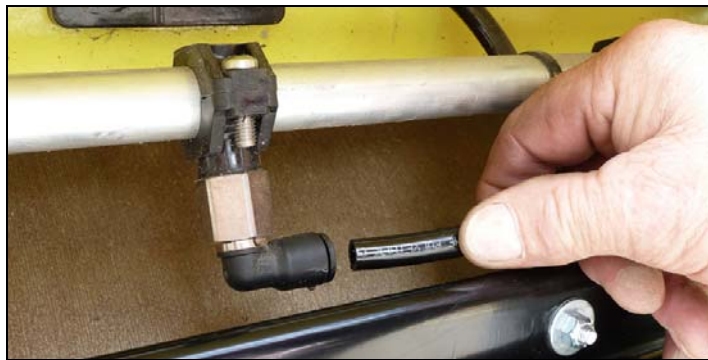

Fig. 11-1 Draining sprinkling water

**11.2.2 Removing the water filter**

The plastic container must be removed if there is a risk of freezing. The water would crack the container if it were to freeze.

- 1 Unscrew the plastic container **(1)** of the water filter.



Fig. 11-2 Water filter

**NOTE**

**Press the battery cut-off switch if storing for more than two days.**

**If no battery cut-off switch is fitted to your roller, remove the negative battery cable from the battery if a standstill period of more than two weeks is expected.**



**12**

# **Transport**

## 12.1 Transport

	<b>⚠ DANGER</b>
	<p><b>Risk of crushing through presence in the pivoting area (danger zone)!</b></p> <ul style="list-style-type: none"> <li>The articulated joint lock (joint protection) must be fitted before lifting the roller for transport.</li> </ul>

### 12.1.1 Joint protection

*Blocking the joint protection*

- 1 Release the lower part of the joint protection (1).
  - 1.1 First, remove the compression spring (2) and then the lock bolt (3).
- 2 Carefully turn the roller steering wheel until the joint protection comes in line with the opposite loop.

**NOTE** You must start the roller to be able to move the steering wheel.

	<b>⚠ DANGER</b>
	<p><b>Risk of crushing through presence in the pivoting area (danger zone)!</b></p> <ul style="list-style-type: none"> <li>As soon as the roller is aligned, shut it off again.</li> </ul>

- 3 Hook the joint protection into place.
- 4 Secure the joint protection with the lock bolt (3).
- 5 Secure the lock bolt with the compression spring (2).

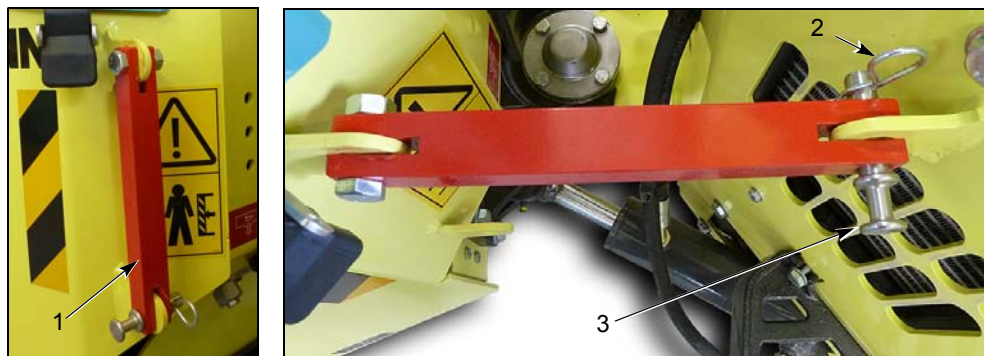

Fig. 12-1 Joint protection open / joint protection locked in place



**12.1.2**

***Lifting at the 1-point lifting eye***



- 1 Bring the joint protection into place.
- 2 Lift the roller vertically with suitable hoisting tackle.
  - 2.1 Use suitable hoisting tackle having the same length as the ARX. 1.

The 1-point lifting eye is designed for a WLL of 1.7 tons (Working Load Limit).



Fig. 12-2 1-point lifting eye

	<p><b>! DANGER</b></p>
	<p><b>Danger to life through suspended loads!</b></p> <ul style="list-style-type: none"> <li>Persons should not linger beneath suspended loads!</li> </ul>

**NOTE**

The roller will weight less if the water tanks are drained before transporting.

**12.1.3**

***Securing the roller on the transporter***



- 1 Bring the joint protection into place.
- 2 Attach the lashing straps to the lashing rings on the roller and on the truck
  - 2.1 Lashing method: Direct lashing/diagonal lashing as shown in photo
  - 2.2 Use a lashing strap with a permissible tensile force of LC = 2,500 daN

The lashing rings on the roller are designed for a permissible tensile force of 2,500 daN.

Permissible angle ranges for diagonal lashing:

- $0^\circ \leq \alpha \leq 60^\circ$
- $30^\circ \leq \beta \leq 60^\circ$



Fig. 12-3 Lashing the roller / side view

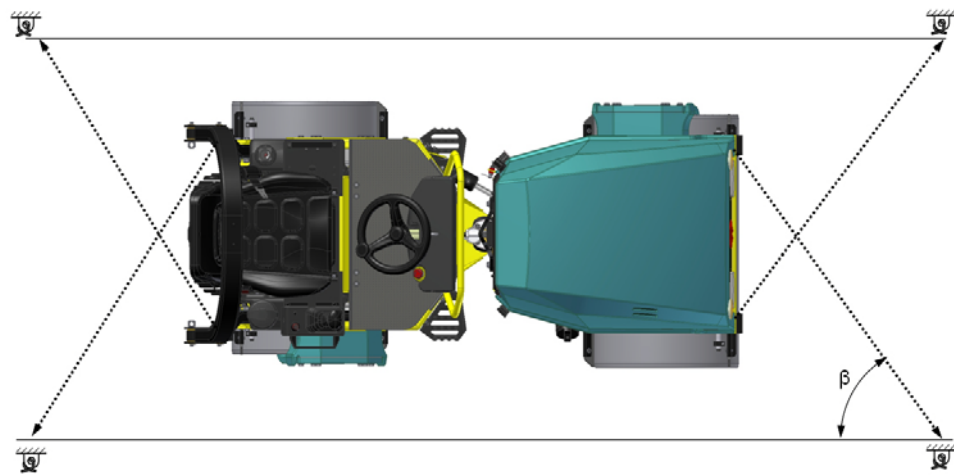



Fig. 12-4 Lashing the roller / front view

	<p><b>⚠ CAUTION</b></p>
	<p><b>Risk of accident through blocked steering!</b></p> <ul style="list-style-type: none"> <li>• Open the joint protection before starting the roller.</li> </ul>

**12.1.4**

**Center of gravity**

The center of gravity relevant to transport is located 670mm from the floor and approx. in the center of the roller, depending on the fill level of the diesel or water tanks.



*Fig. 12-5 Roller's center of gravity*



**13**

# **Disposal**

## 13.1 Introduction

	<b>⚠ CAUTION</b>
	<p><b>Environmental hazard through operating materials!</b></p> <ul style="list-style-type: none"> <li>• Do not allow any liquids get into drains, soil or the environment.</li> </ul>

The roller must be disposed of properly; ask your authorized dealer.

## 13.2 Removal and depressurization of the gas struts

	<b>⚠ WARNING</b>
	<p><b>Eye injury!</b></p> <p><b>Because of the high internal pressure, chips and oil can spatter from the site of sawing or drilling.</b></p> <ul style="list-style-type: none"> <li>• Wear eye and face protection.</li> <li>• Cover the site of the saw cut.</li> </ul>

	<b>⚠ CAUTION</b>
	<p><b>Environmental hazard through operating materials!</b></p> <p><b>Gas struts are filled with oil.</b></p> <ul style="list-style-type: none"> <li>• Do not allow any liquids get into drains, soil or the environment.</li> </ul>

In case of disposal, pressurized gas struts must be depressurized according to the following regulations:

- 1 Fasten the pressurized tube between two prismatic jaws without deforming it and in such a way that the dimension X is at least 25mm (see below).
- 2 To depressurize:
  - 2a Slowly cut the pressurized tube open at the points indicated using a **handsaw** or,
  - 2b Drill a hole in the tube using a **drill** with about a 3 mm diameter.

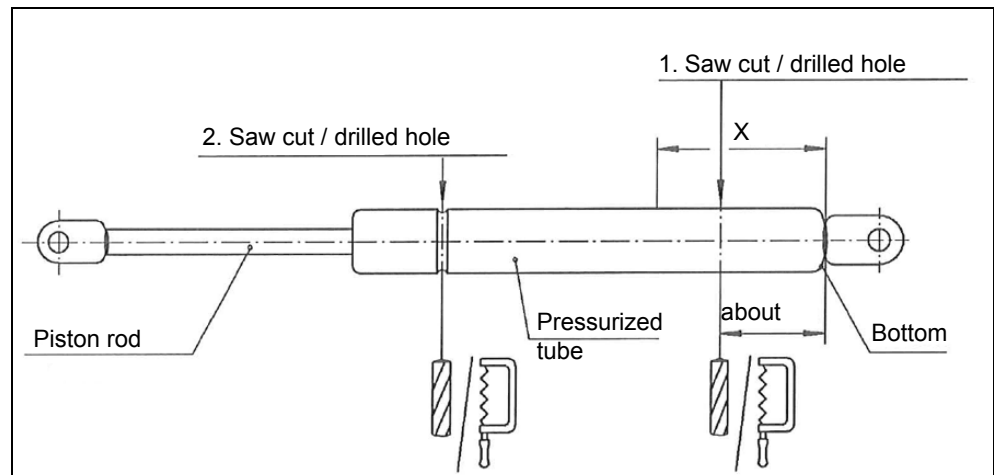

Fig. 13-1 Removal and depressurization of the gas struts

- 1. saw cut / hole position: Cut or drill into the pressurized tube about 20 mm from the bottom.
- 2. saw cut / hole position: Cut or drill into the pressurized tube in the bead.

**NOTE**

**If disposal according to these regulations is not possible, ask your authorized dealer.**





**14**

# **Appendix**

# 14.1 Wiring diagram, ARX 1

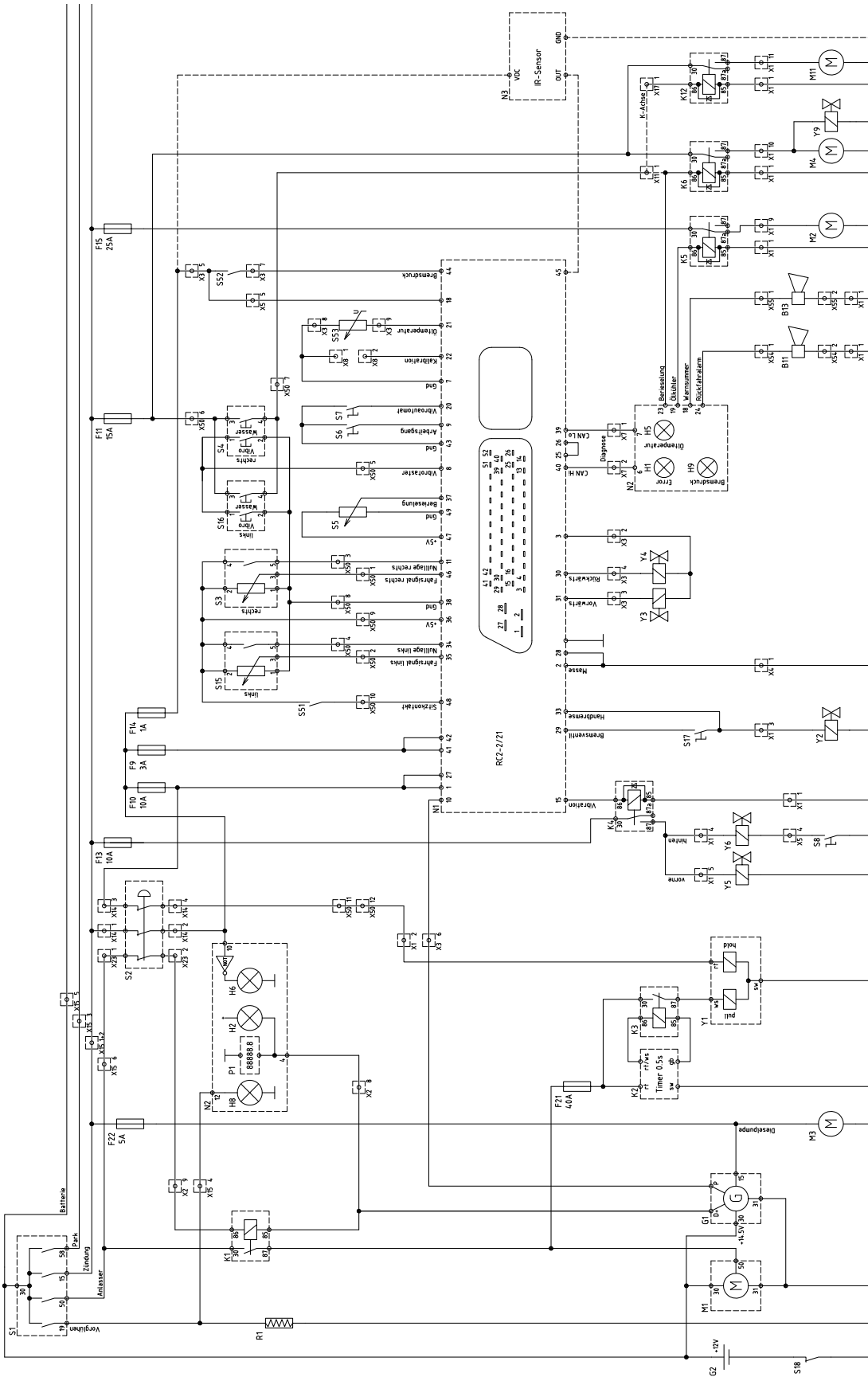

Fig. 14-1 Wiring diagram no. 1202835-1

1201281 | 29.06.2012

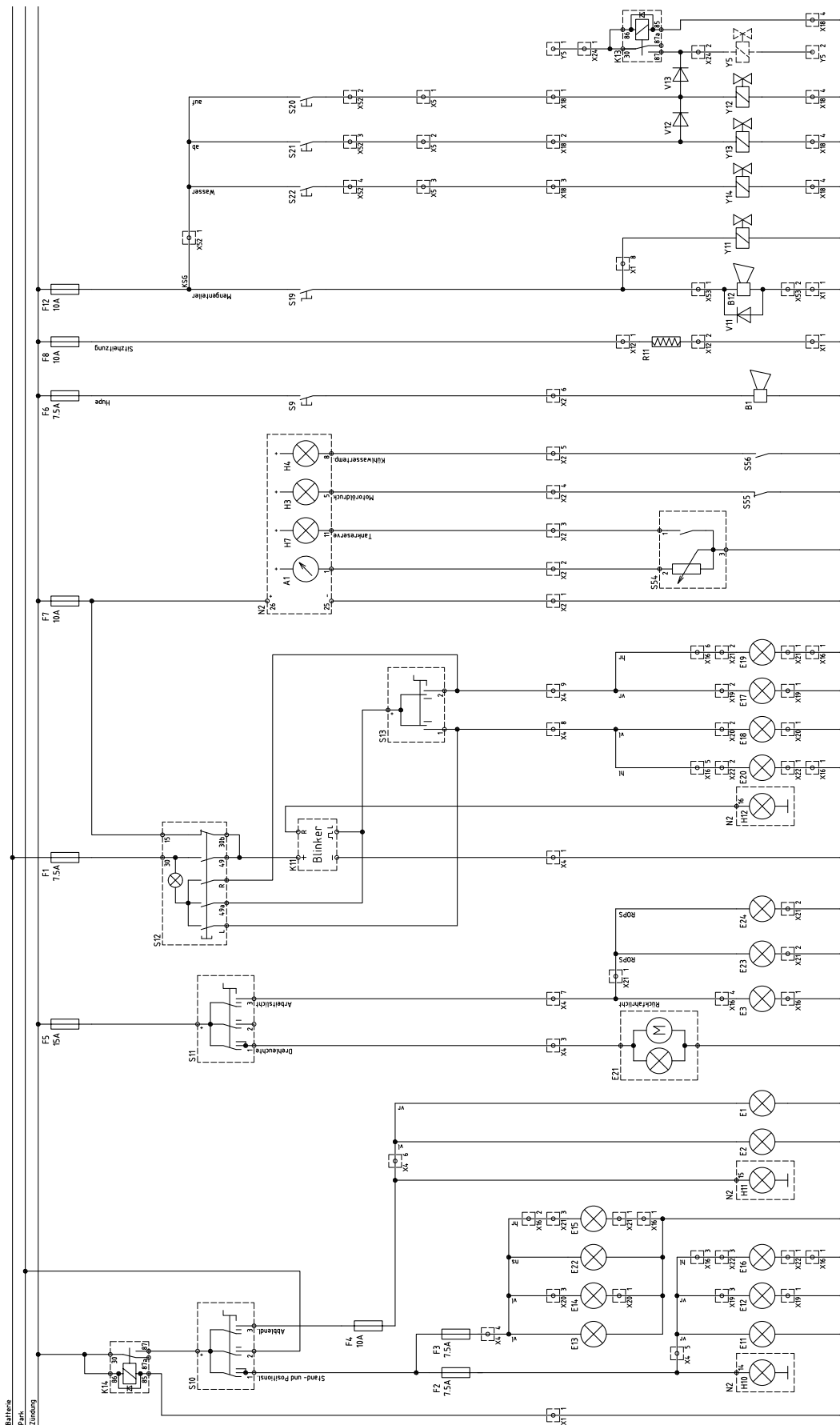

Fig. 14-2 Wiring diagram no. 1202835-2

**14.1.1**
**Key for ARX 1 wiring diagram**

Element	Description
A1	Diesel tank fuel level display
A2	Voltage display
B1	Horn
B11	Reversing alarm
B12	Warning buzzer, flow divider
B13	Warning buzzer, seat contact delay
E1	Front right low beam light
E2	Front left low beam light
E11	Front right parking light
E12	Front right position light
E13	Front left parking light
E14	Front left position light
E15	Rear right parking light
E16	Rear left parking light
E17	Front right indicator
E18	Front left indicator
E19	Rear right indicator
E20	Rear left indicator
E21	Revolving warning light
E22	License plate illumination
E23	Work light rear
F1	Fuse, hazard flasher
F2	Fuse, parking light 1
F3	Fuse, parking light 2
F4	Low beam light fuse
F5	Fuse, revolving warning light, work light
F6	Fuse, horn
F7	Fuse, display unit, reverse alarm, blinker
F8	Fuse, Seat heating
F9	Fuse, controller, supply
F10	Fuse, controller, outputs
F11	Fuse, sprinkler
F12	Fuse, flow divider, edge cutter
F13	Fuse - vibration

Element	Description
F14	Fuse, controller, inputs
F15	Fuse, hydraulic oil cooler
F16	Fuse, reserve
F21	Fuse, starter
F22	Fuse, diesel pump
F23	Fuse, reserve
F24	Fuse, reserve
G1	Alternator
G2	Battery
H1	Warning lamp, error
H2	Control lamp, charging control
H3	Warning lamp - engine oil pressure
H4	Warning lamp - coolant temperature
H5	Warning lamp, hydraulic oil temperature
H6	Warning lamp, emergency stop
H7	Warning lamp, diesel reserve
H8	Control lamp, pre-heating
H9	Control lamp, brake pressure
H10	Control lamp, parking lights
H11	Control lamp, dipped lights
H12	Control lamp, blinker
K1	Relay, starting interlock
K2	Timer relay
K3	Relay, pull-in solenoid
K4	Relay, vibration
K5	Relay, hydraulic oil cooler
K6	Relay, sprinkler
K7 **	Relay, starting interlock
K8	Relay, sprinkler
K11	Relay, blinker
K12	Relay, anti-adhesive sprinkler
K13	Relay, edge cutter
K14	Relay, light
K15 **	Relay, front vibration
K16 **	Relay, rear vibration

Element	Description
M1	Starter motor
M2	Hydraulic oil cooler
M3	Diesel pump
M4	Sprinkler pump
M11	Sprinkler pump, anti-adhesive
N1	Controller
N2	Display unit
N3	Measuring transducer, asphalt temperature
P1	Operating hours counter
R1	Pre-heating coil
R11	Seat heating
S1	Switch, ignition
S2	Switch, emergency stop
S3	Operating lever sensor, right
S4	Operating lever switch, right
S5	Potentiometer, sprinkler
S6	Switch, work gear
S7	Switch, vibration automation
S8	Switch, rear vibration
S9	Switch, horn
S10	Switch, parking light / low beam light
S11	Switch, revolving warning light, work light
S12	Switch, hazard flasher
S13	Switch, indicator
S14	Switch, vibration selector **
S15	Operating lever sensor, left *
S16	Operating lever switch, left *
S17	Switch, parking brake
S18	Battery cut-off switch *
S19	Switch, flow divider *
S20	Switch, edge cutter up *
S21	Switch, edge cutter down *
S22	Switch, edge cutter, water *
S51	Sensor, seat contact
S52	Sensor, brake pressure

Element	Description
S53	Sensor, hydraulic oil temperature
S54	Sensor, diesel tank
S55	Sensor, engine oil pressure
S56	Sensor, coolant temperature
V11	Free-running diode, buzzer, flow divider
V12 *	Free-running diode, edge cutter 1
V13 *	Free-running diode, edge cutter 2
Y1	Pull-in / holding solenoid
Y2	Valve, locking brake
Y3	Drive pump, forwards
Y4	Drive pump, backwards
Y5	Valve, front vibration
Y6	Valve, rear vibration
Y7 **	Valve, large amplitude vibration
Y8 **	Valve, small frequency vibration
Y9	Shut-off valve, sprinkler pump
Y11 *	Valve, flow divider
Y12 *	Valve, edge cutter
Y13 *	Valve, edge cutter
Y14 *	Valve, edge cutter water

(\*) Optional

(\*\*) Not available

**14.2 Hydraulics diagram, ARX 1**

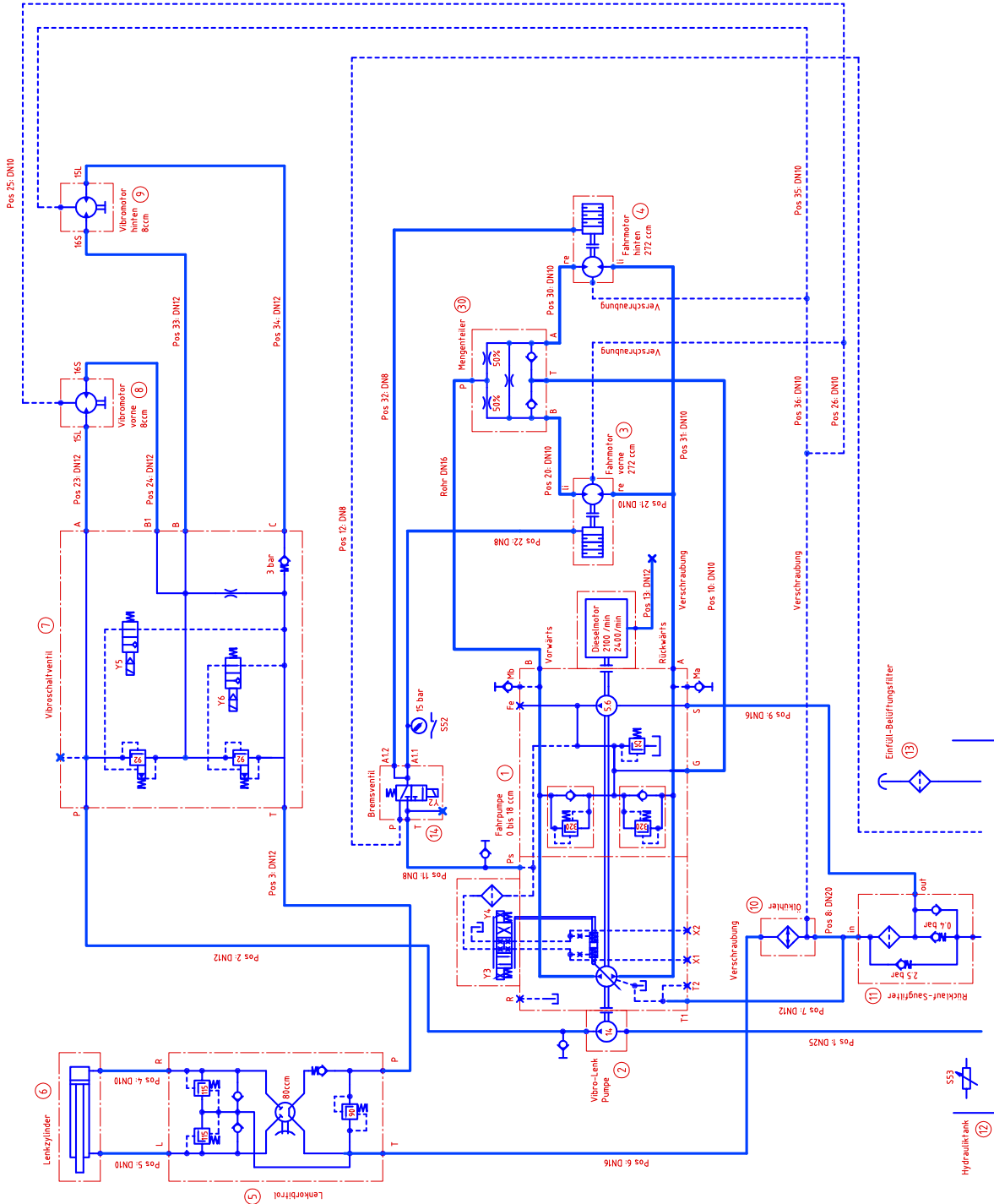

Fig. 14-3 Hydraulics diagram no. 1193831



**14.2.1**
**Key for ARX 1 hydraulics diagram**

Element	Description
1	Drive pump
2	Vibro-steering pump
3	Front drive motor
4	Rear drive motor
5	Steering orbitrol
6	Steering cylinder
7	Vibro switch valve
8	Vibro motor, front
9	Vibro motor, rear
10	Oil cooler
11	Return-line suction filter
12	Hydraulic oil tank
13	Filler, ventilation filter
14	Brake valve
30	Flow divider

### 14.3 Hydraulics diagram, ARX 1 K

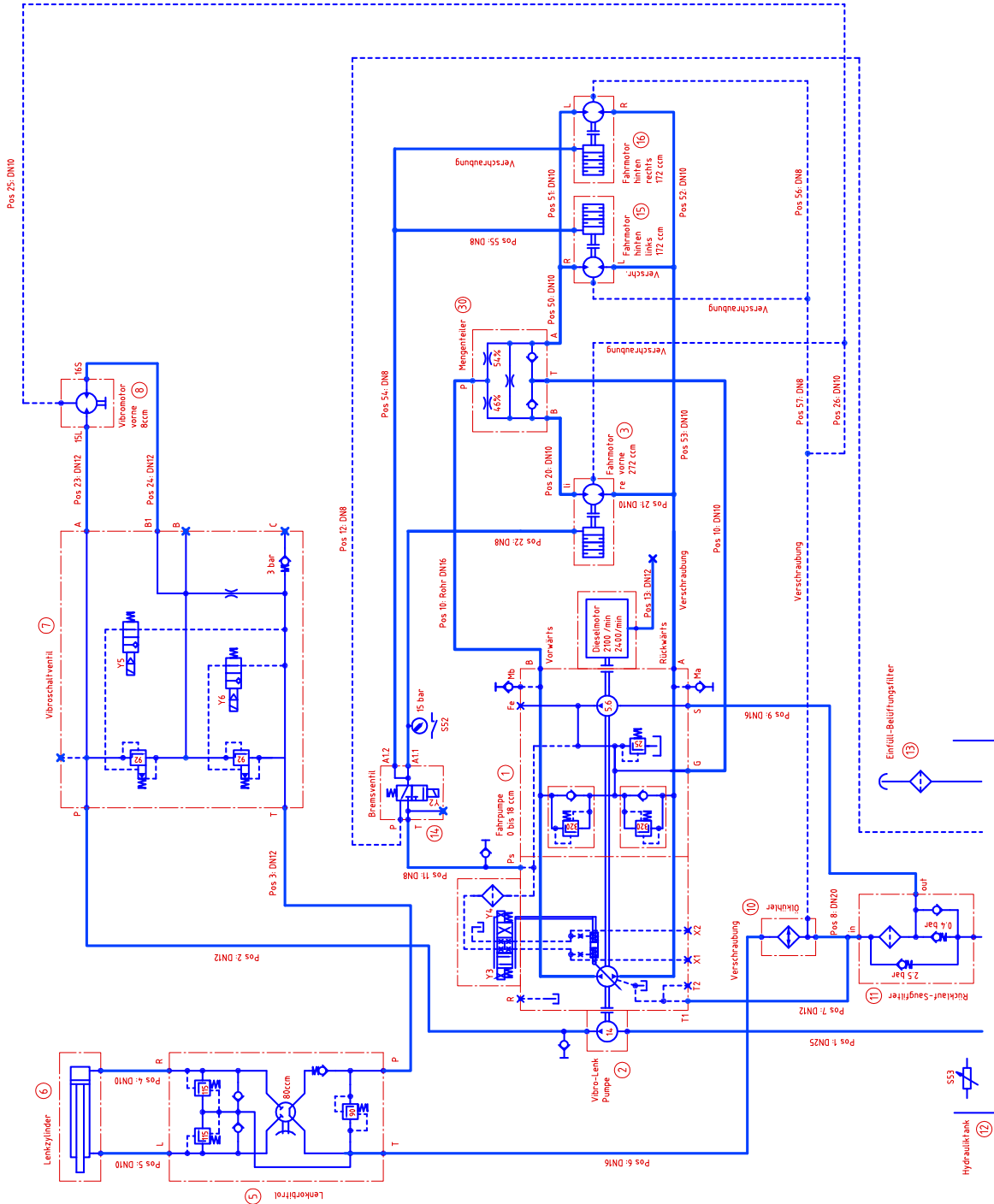
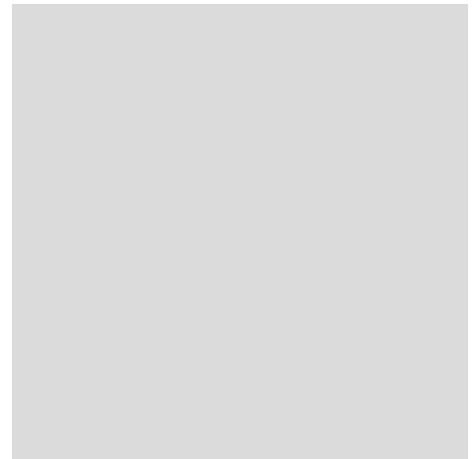

Fig. 14-4 Hydraulics diagram no. 1193830

**14.3.1**
**Key for ARX 1 K hydraulics diagram**

Element	Description
1	Drive pump
2	Vibro-steering pump
3	Front drive motor
4	Rear drive motor
5	Steering orbitrol
6	Steering cylinder
7	Vibro switch valve
8	Vibro motor, front
9	Vibro motor, rear
10	Oil cooler
11	Return-line suction filter
12	Hydraulic oil tank
13	Filler, ventilation filter
14	Brake valve
15	Drive motor, rear left
16	Drive motor, rear right
30	Flow divider





# Tables

Documents for the ARX 1 . . . . .	14
Roller with roller drum . . . . .	20
Roller with pneumatic wheel (combined roller) . . . . .	20
ARX 1 dimensions . . . . .	21
ARX 1 Performance Characteristics . . . . .	22
Fill levels ARX 1 . . . . .	22
Limits for application in consideration of environmental conditions . . . . .	24
ARX 1 sound power level . . . . .	32
Warning stickers on board . . . . .	32
Notice stickers on board . . . . .	35
ARX 1 acceleration data in m/s <sup>2</sup> according to ISO 2631-1 for whole-body vibration . . . . .	36
Error code upon start-up . . . . .	49
Error code during operation . . . . .	49
BUS error message . . . . .	51
Torque: Threaded bolt for ROPS joint . . . . .	56
Anti-adhesive designations . . . . .	78

Excerpt from the Yanmar engine manual about diesel specifications. . . . .	91
Lubricant table. . . . .	109
Consumables . . . . .	110
Torque: hex screws and hex socket head screws (Allen). . . . .	110
Torque: low-profile cylinder head screws and oval head screws . . . . .	111
Torque: Shoulder screws . . . . .	111
Torque: Countersunk head screws . . . . .	111
Torque: Screw plugs . . . . .	111
Torque: Drain cock / hydraulic tank. . . . .	111
Engine compartment fuses . . . . .	117
Steering column fuses. . . . .	117
Long-term storage. . . . .	124